

SPECIFICATION

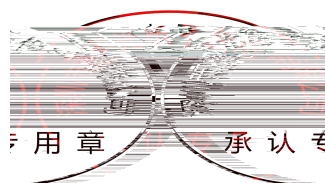

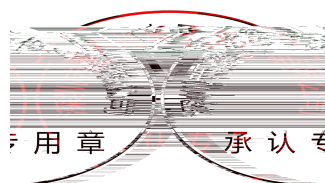



1.4 Package Dimension

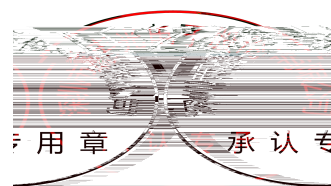
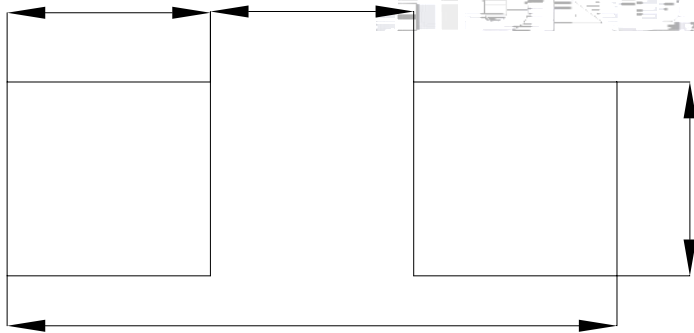
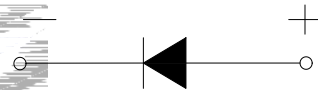
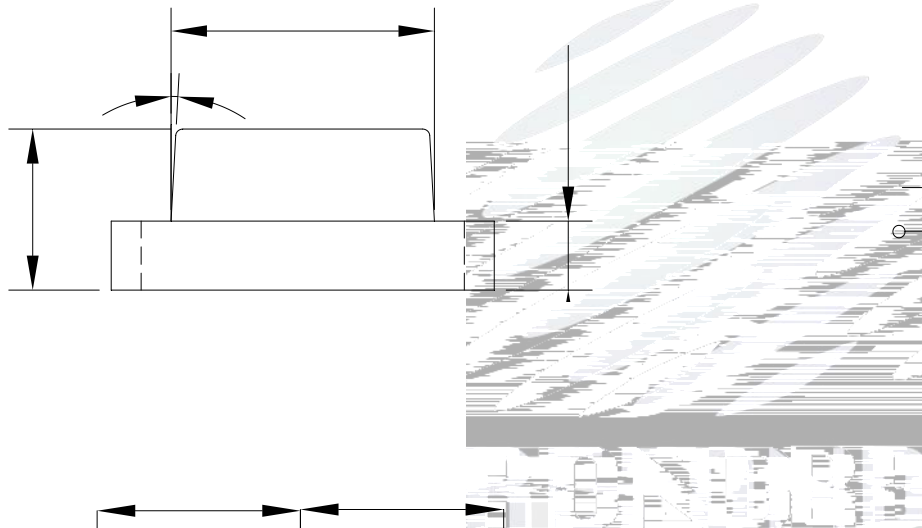
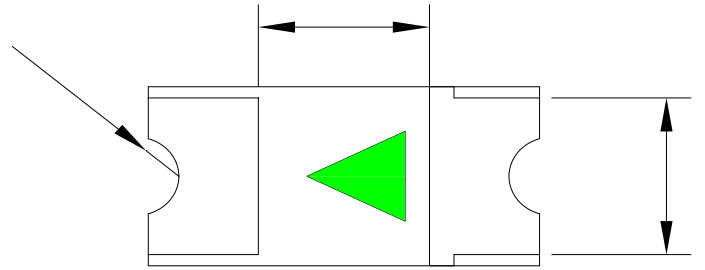
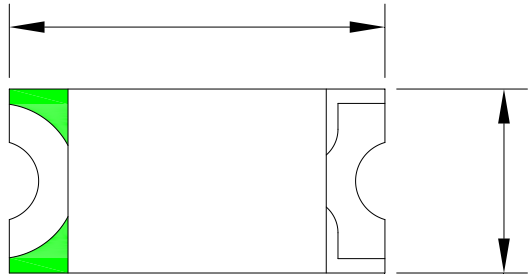

±

1.5 Product Parameters

						μ



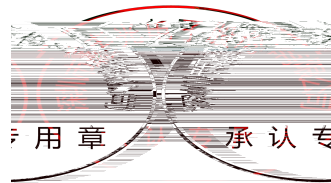

1.6 Typical Optical Characteristics Curves

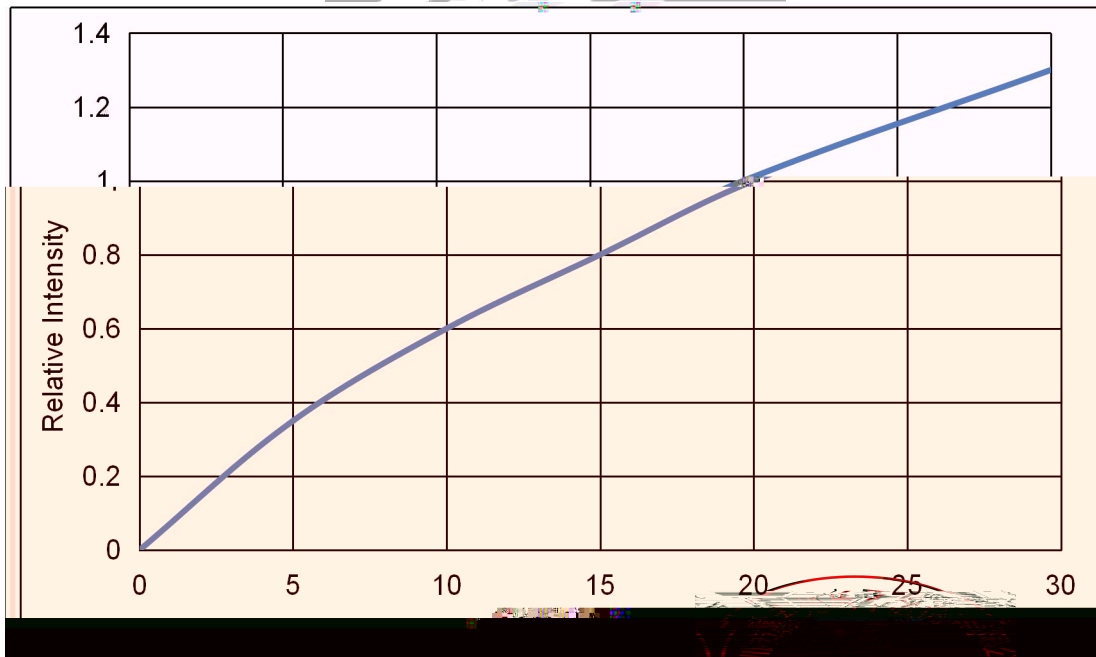
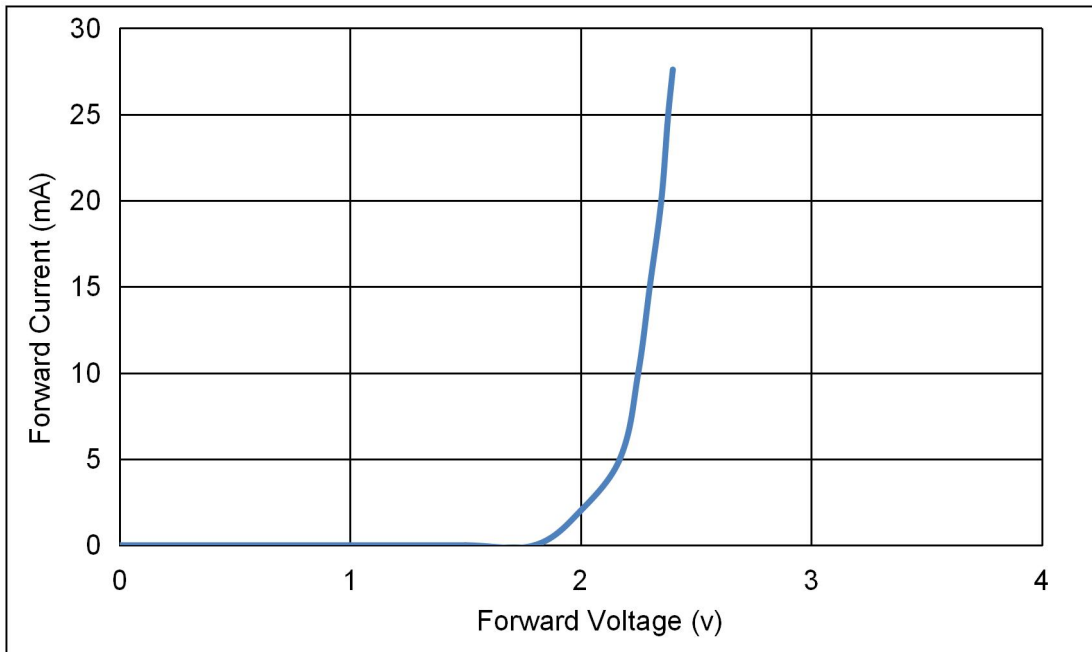

用章 承认专

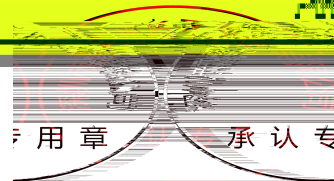
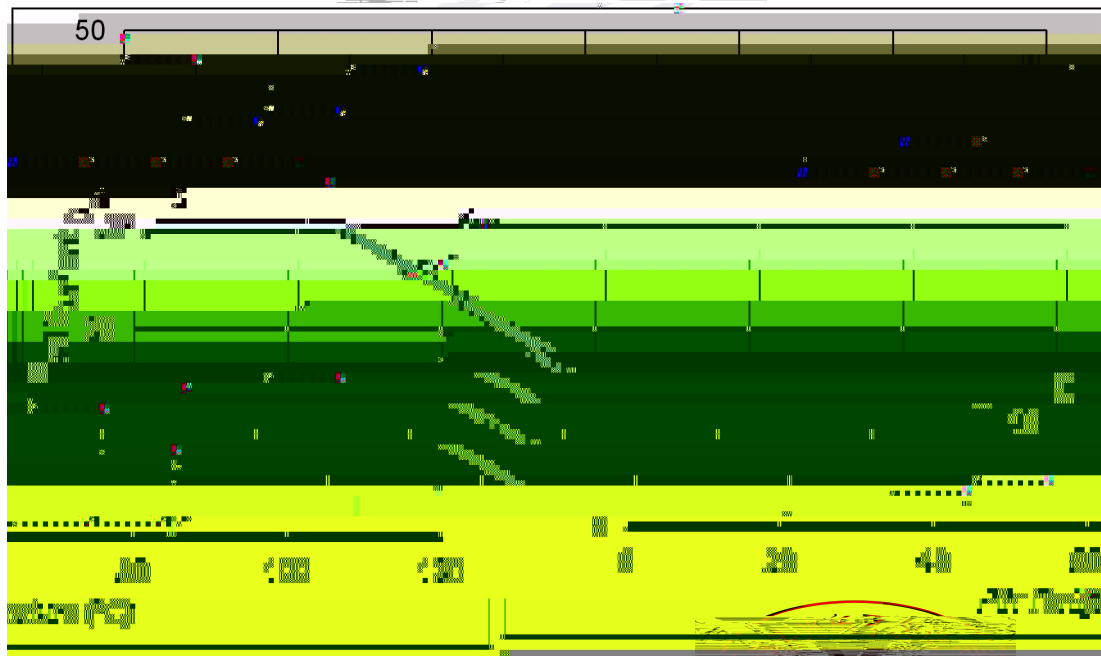
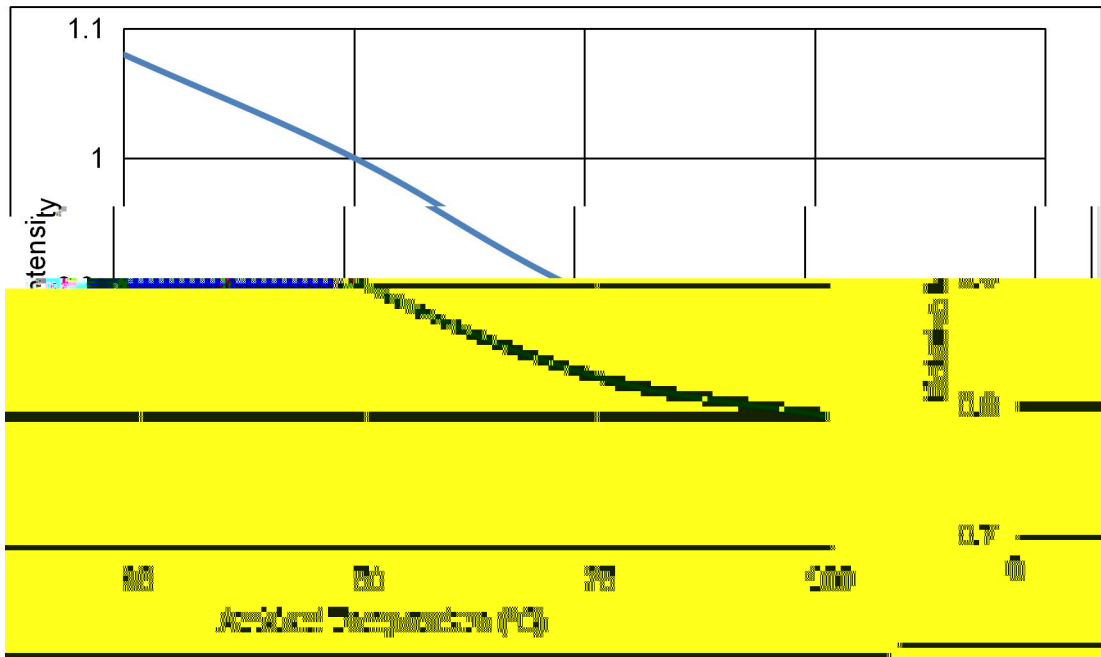

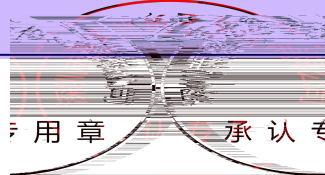
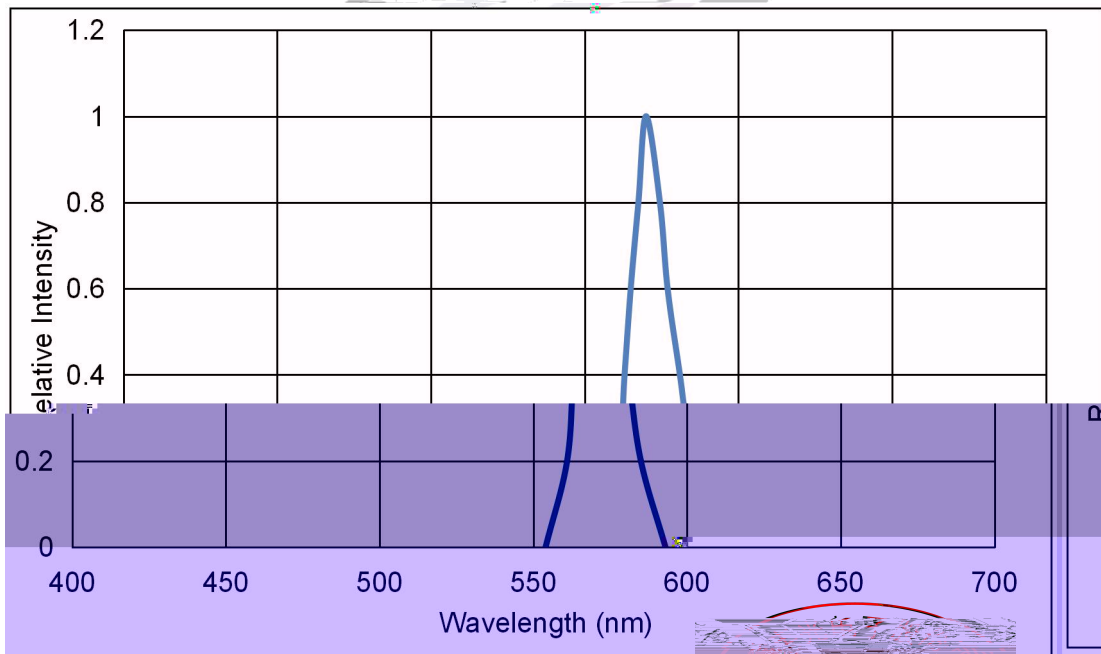
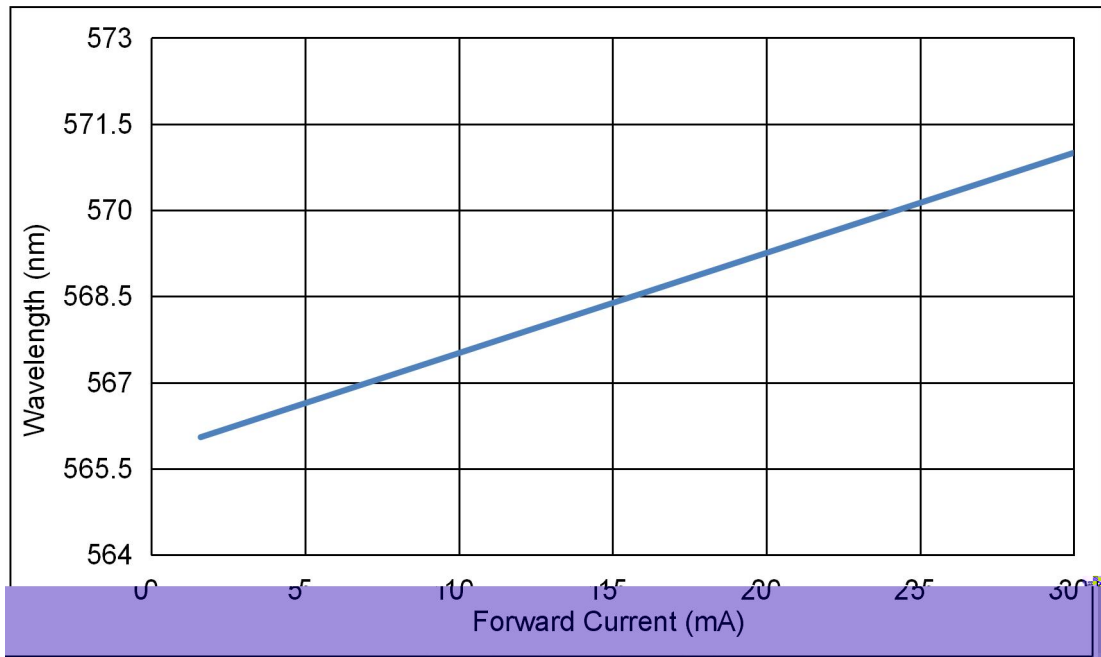

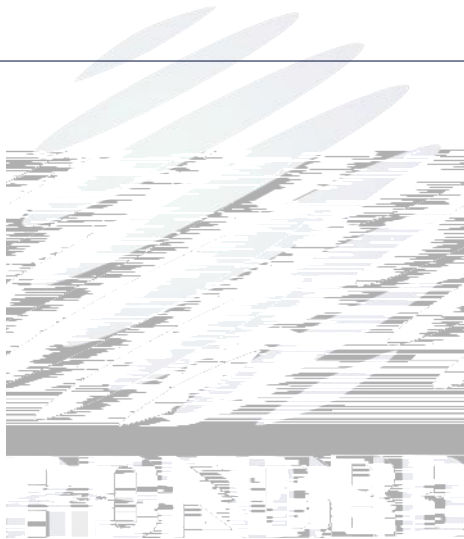
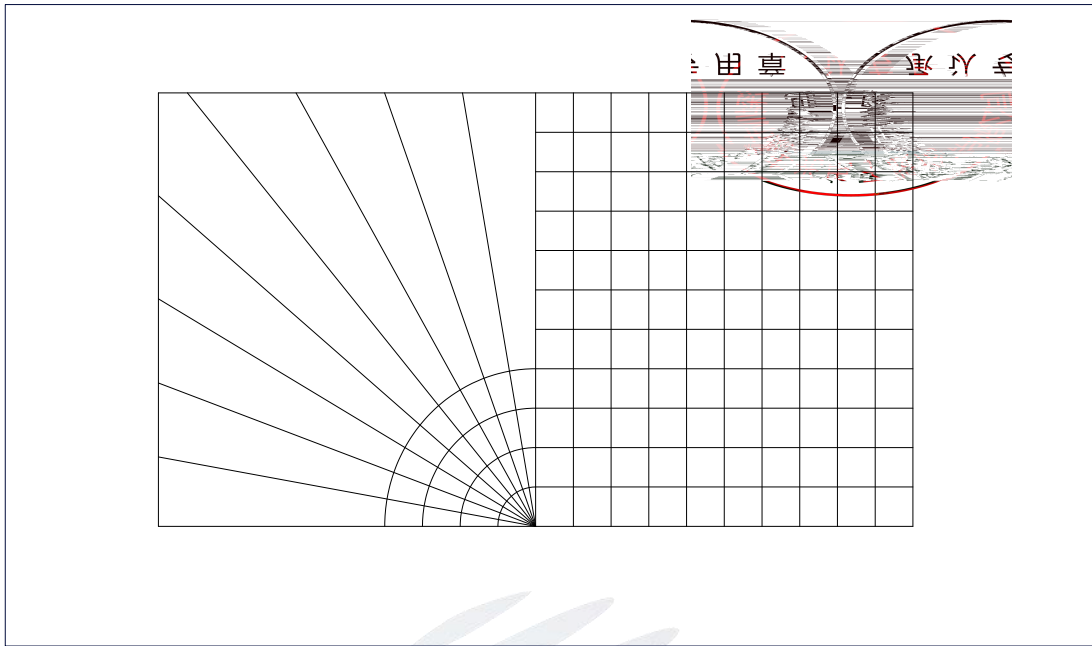



Packa



PART NO:		
SPEC NO:		
LOT NO		
BIN CODE:		
Φ:	XY:	
VF:	WLD:	
	QTY:	
	DATE:	

2.2 Moisture Resistant Packing

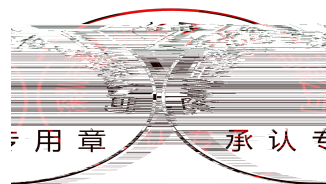
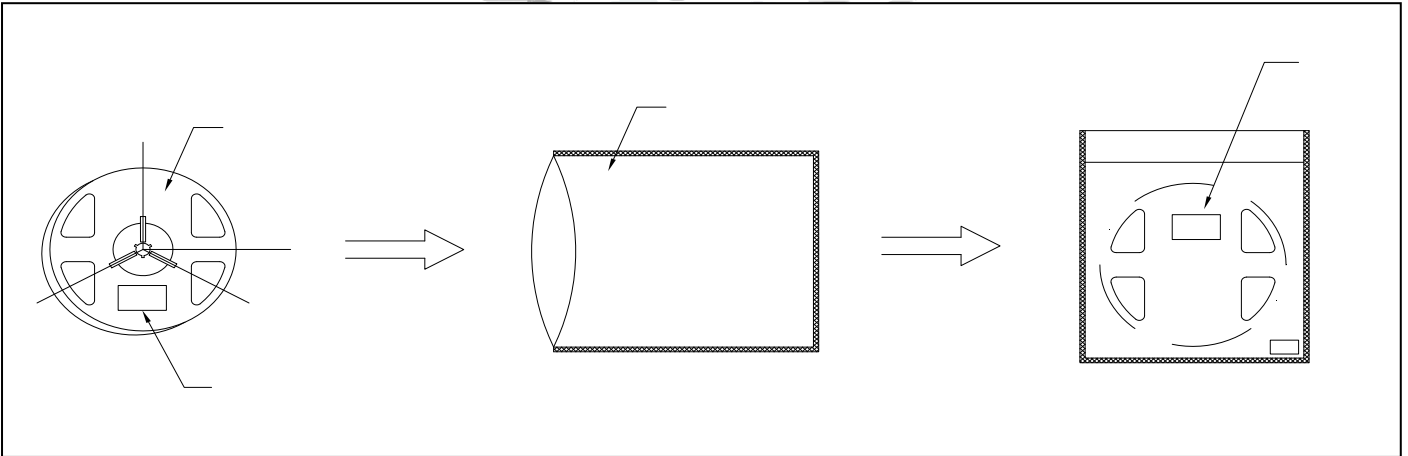

2.3 Cardboard Box

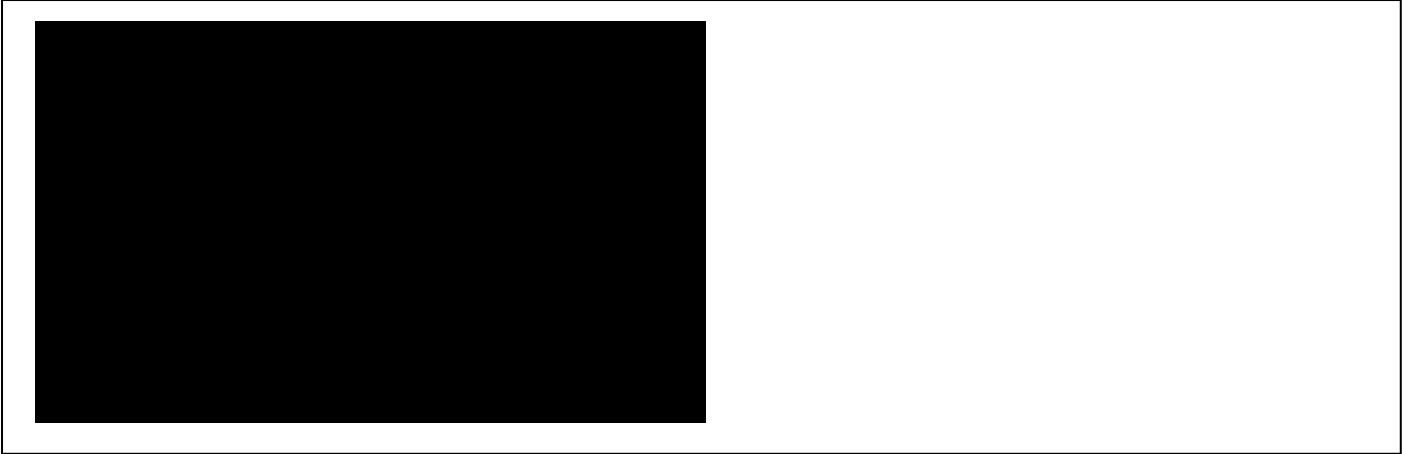

2.4 Reliability Test Items And Conditions

2.5 Criteria For Judging Damage

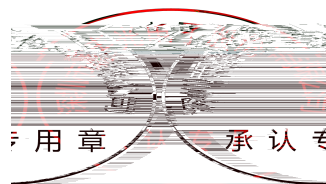
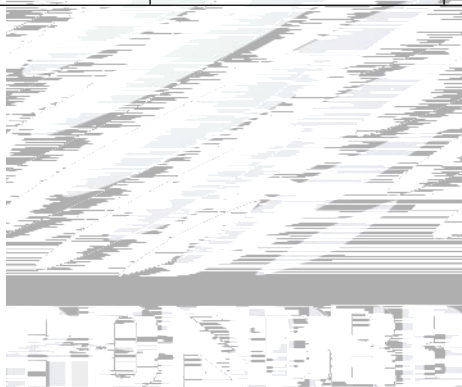

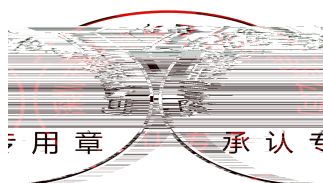

4. Handling Precautions

4.1 Handling Precautions

