

±

| | | | | | | |
|--|--|--|--|--|--|---|
| | | | | | | |
| | | | | | | |
| | | | | | | |
| | | | | | | |
| | | | | | | |
| | | | | | | |
| | | | | | | |
| | | | | | | |
| | | | | | | μ |
| | | | | | | |

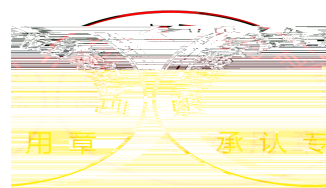

| | | | |
|--|--|--|--|
| | | | |
| | | | |
| | | | |
| | | | |
| | | | |
| | | | |
| | | | |
| | | | |
| | | | |
| | | | |



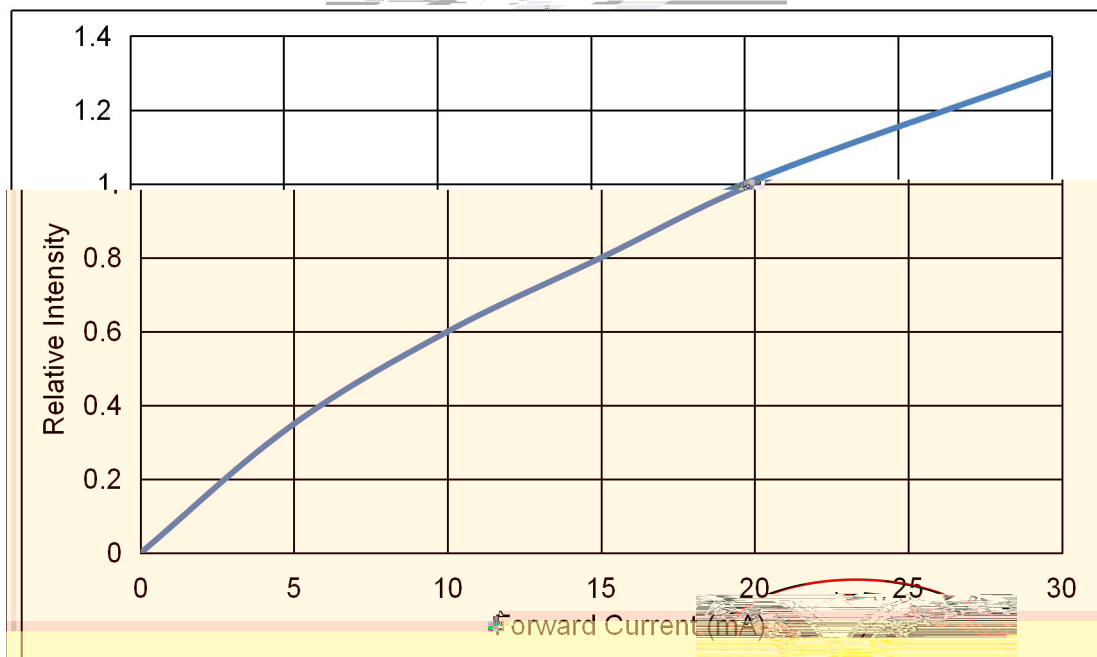
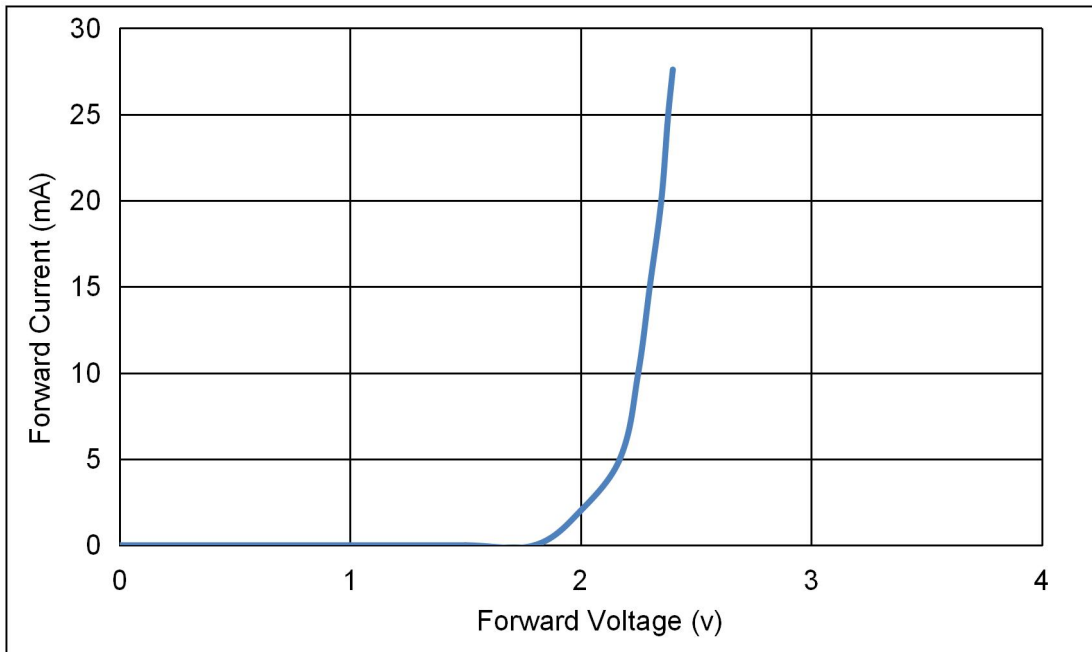

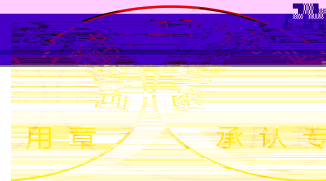
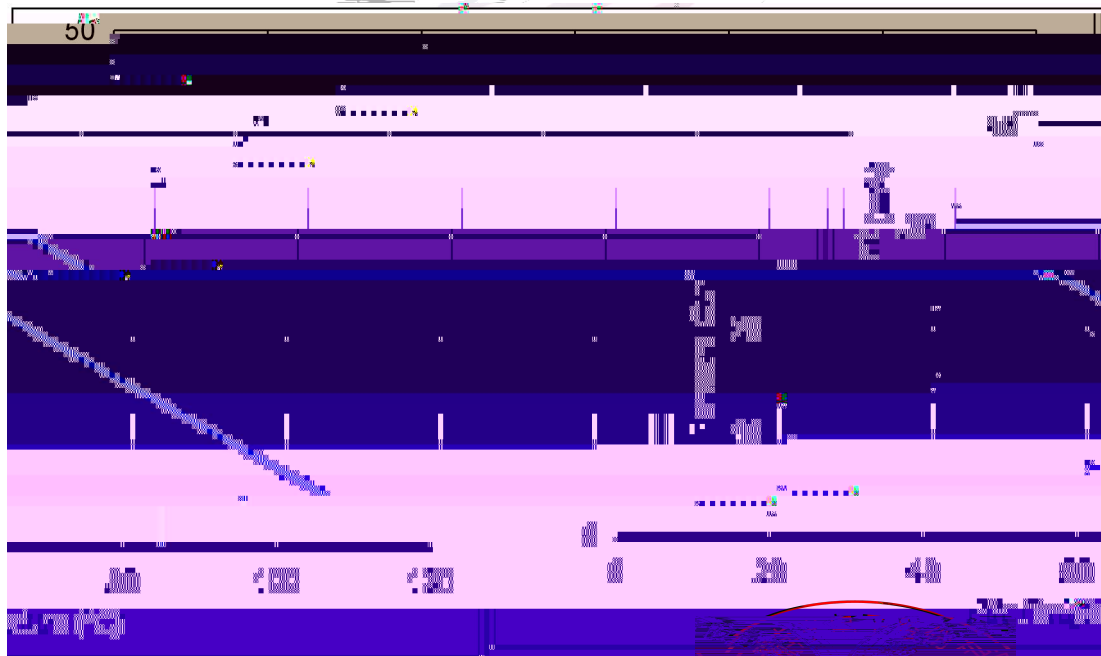
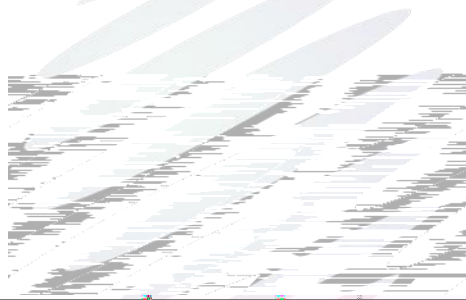
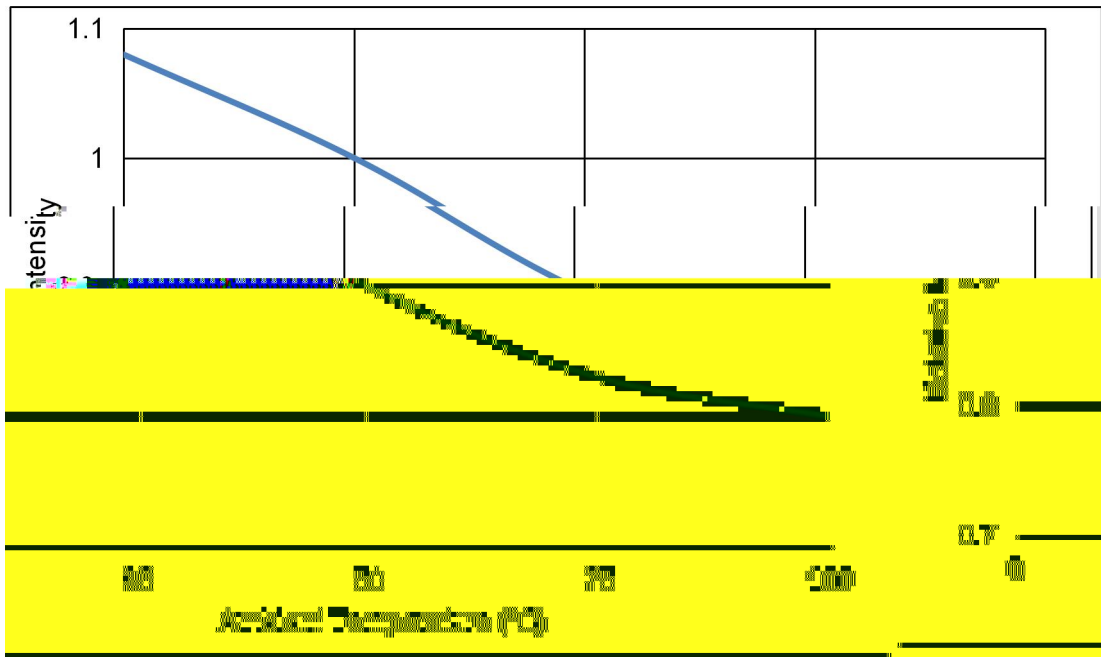

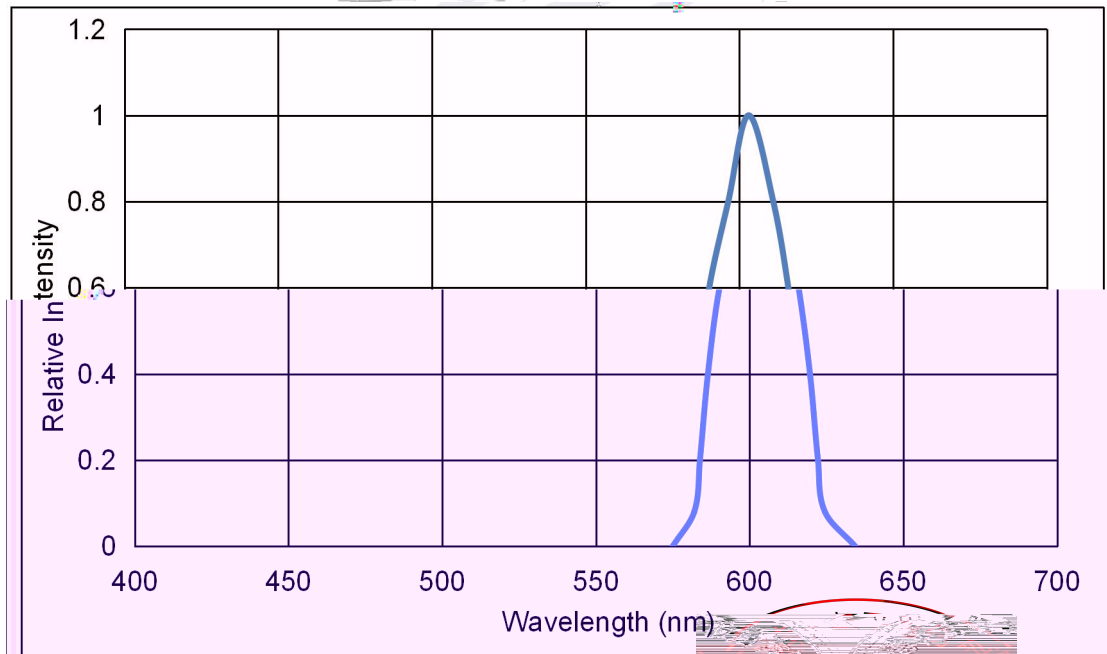
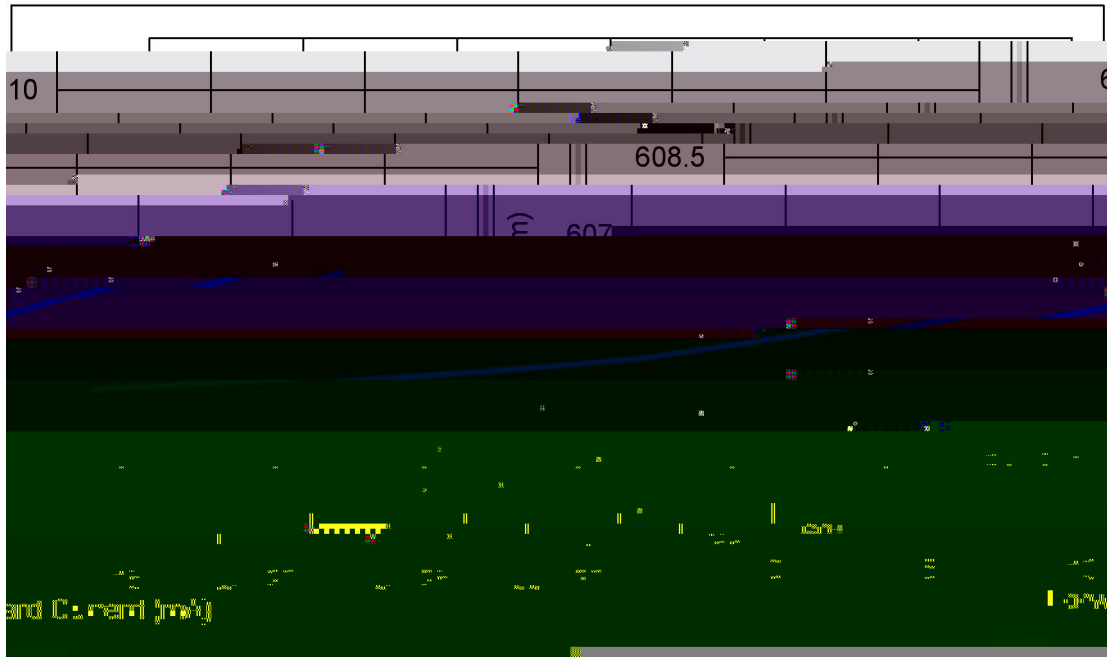

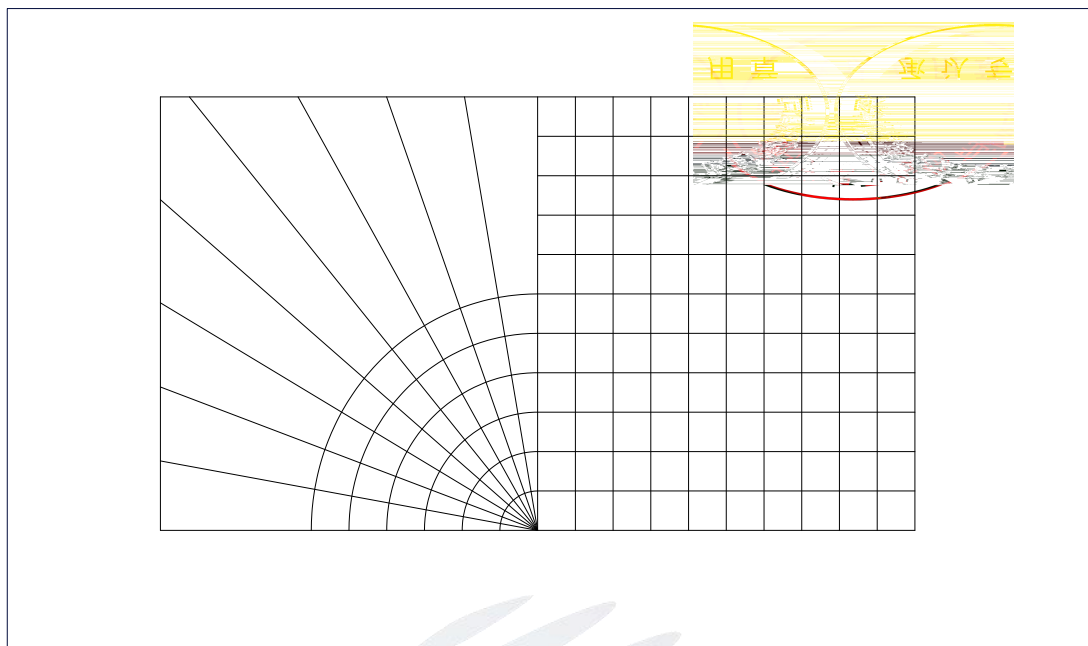

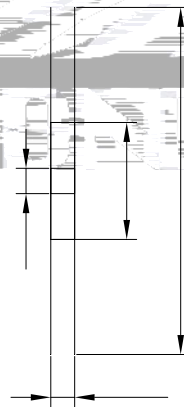
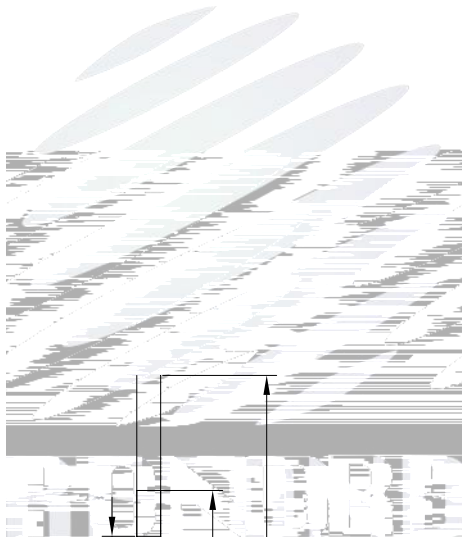
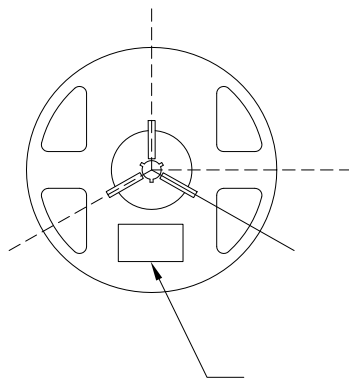



| | |
|--|--|
| | |
| | |
| | |
| | |

| | |
|---|---|
| PART NO: SPEC NO: LOT NO |  |
| BIN CODE: Φ: VF: | XY: WLD: |
|  | QTY: DATE: |



⇒

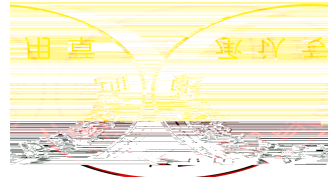

| | | | | |
|--|--|--|------|--|
| | | | | |
| | | | Min. | |
| | | | | |
| | | | | |
| | | | | |

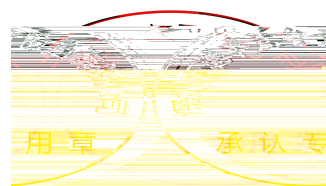



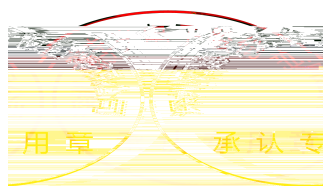

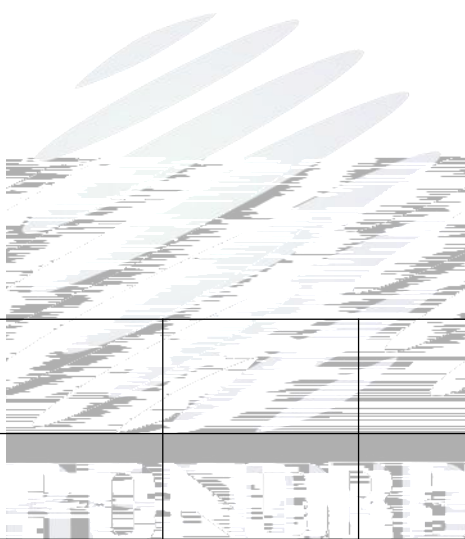

| | | | |
|--|--|--|--|
| | | | |
| | | | |
| | | | |
| | | | |



