

SPECIFICATION

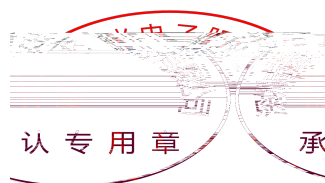

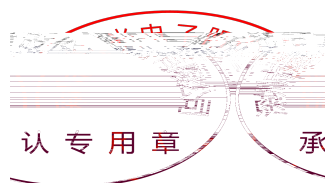



1.4 Package Dimension

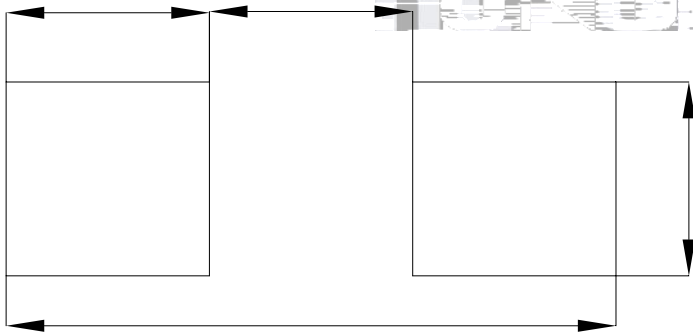
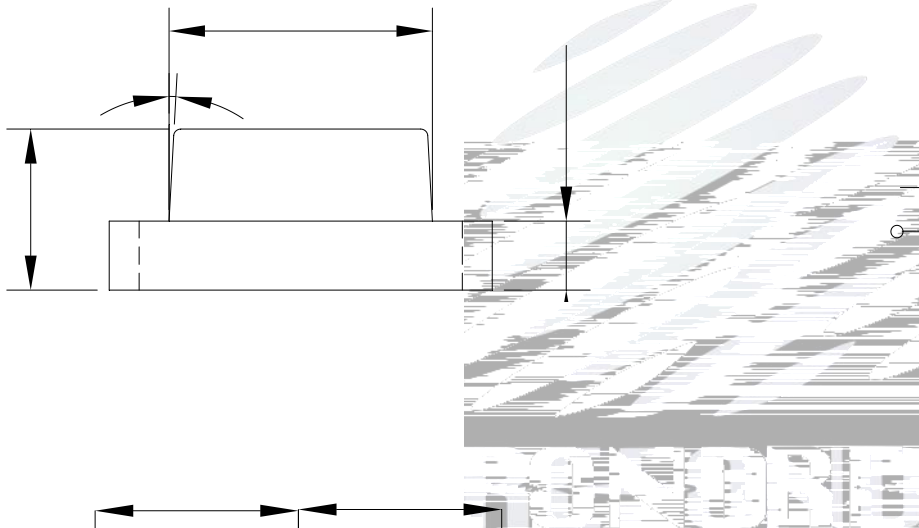
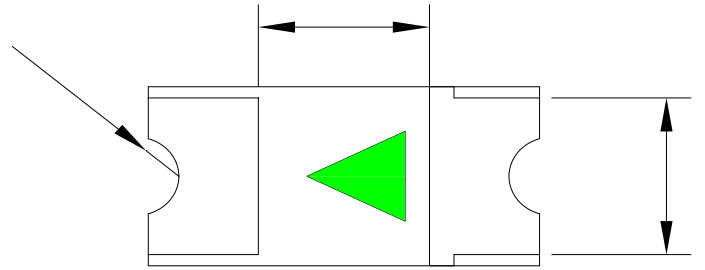
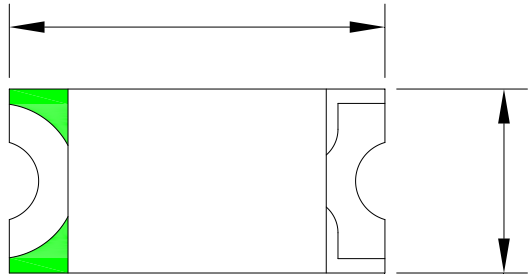

±

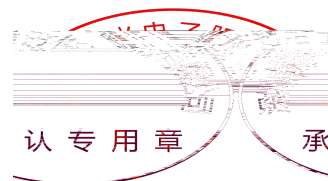



1.6 Typical Optical Characteristics Curves

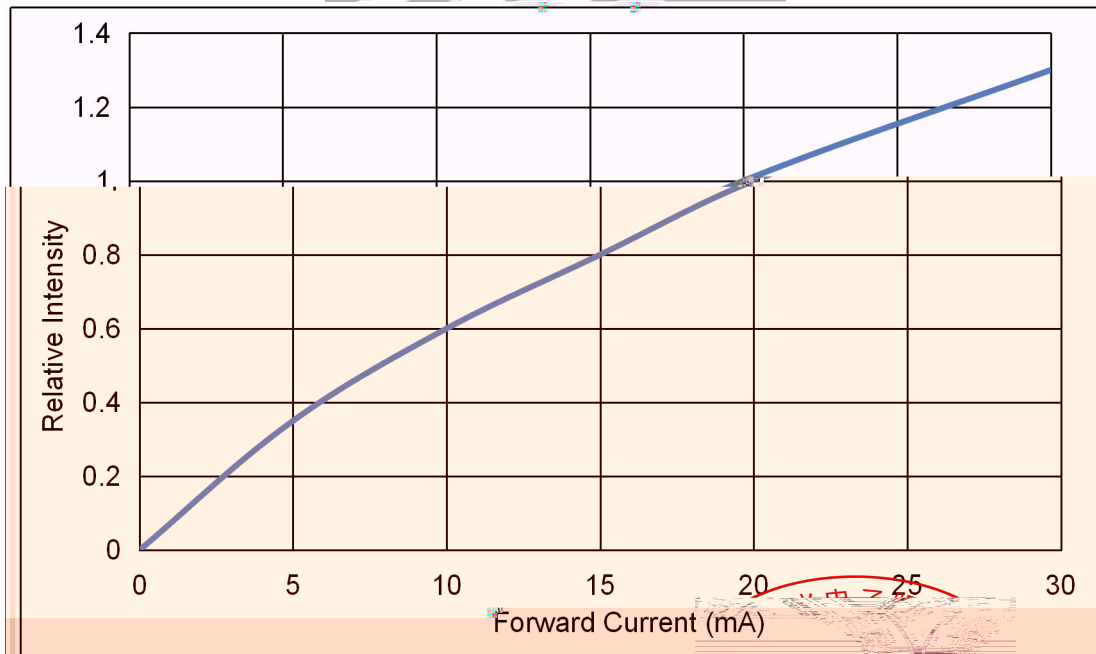
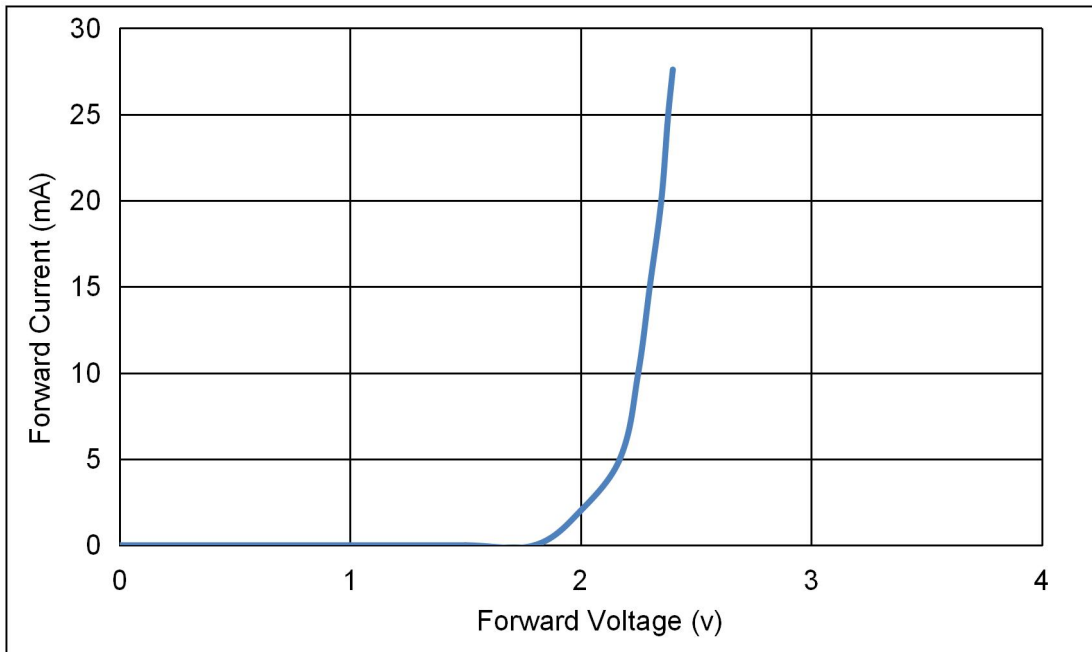

認專用章 承

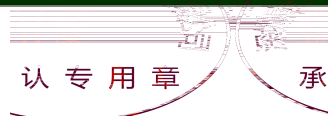
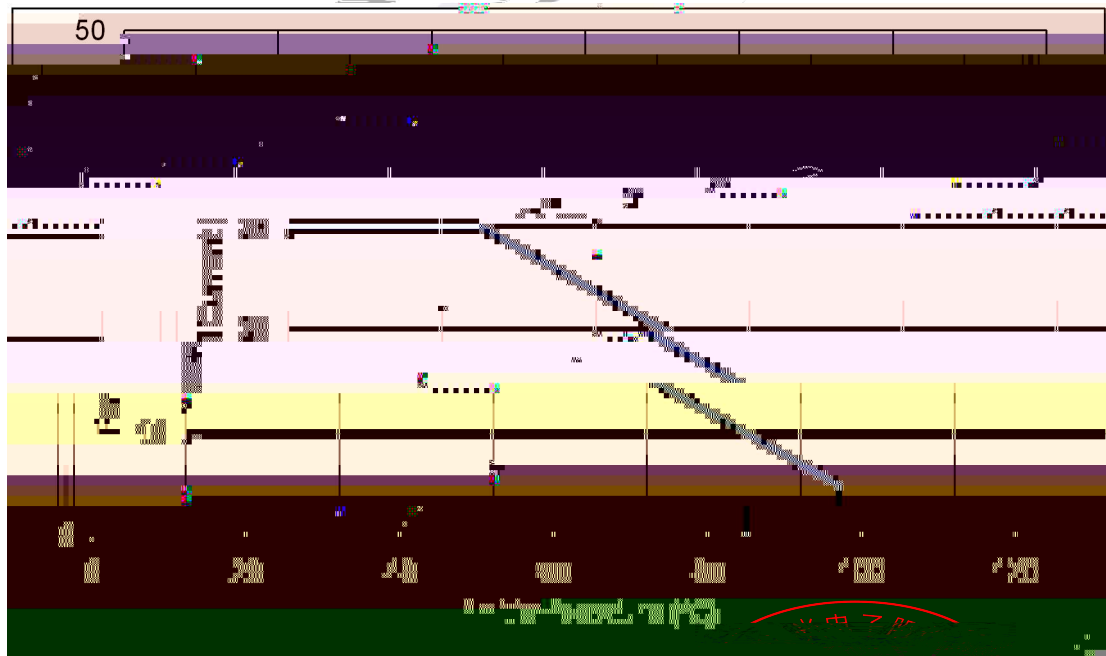
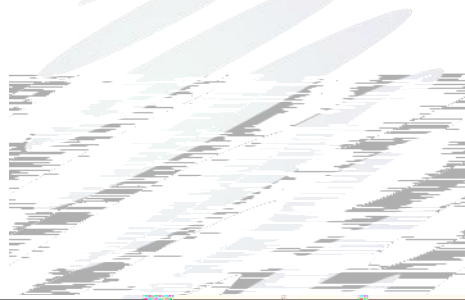
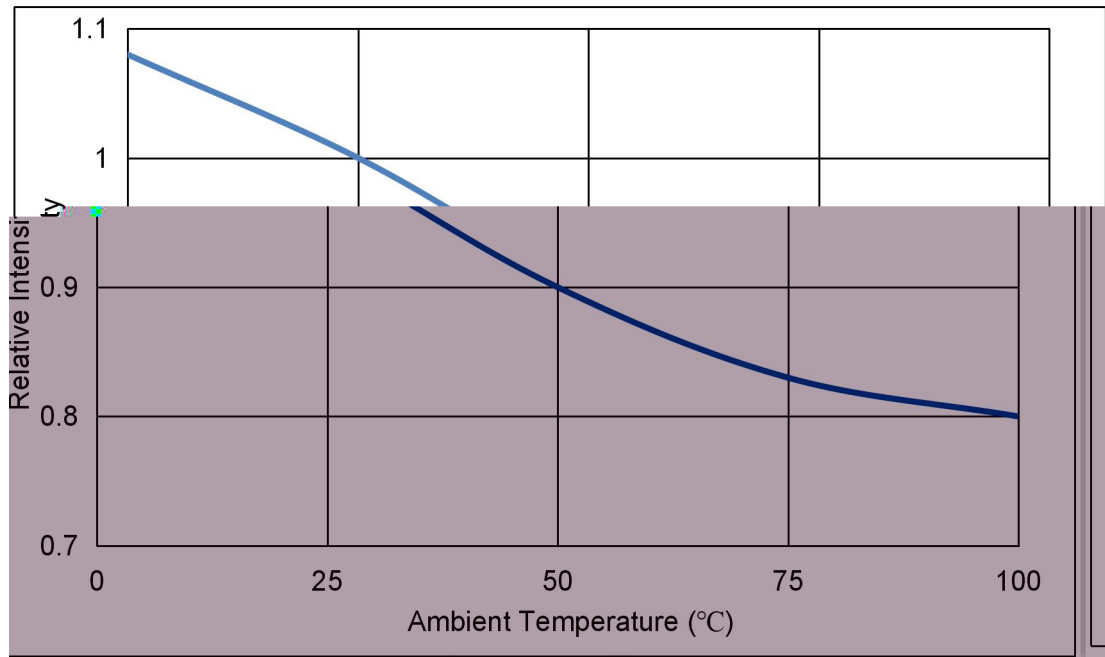

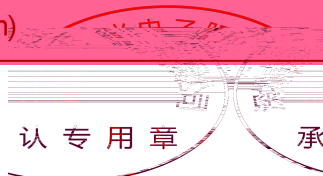
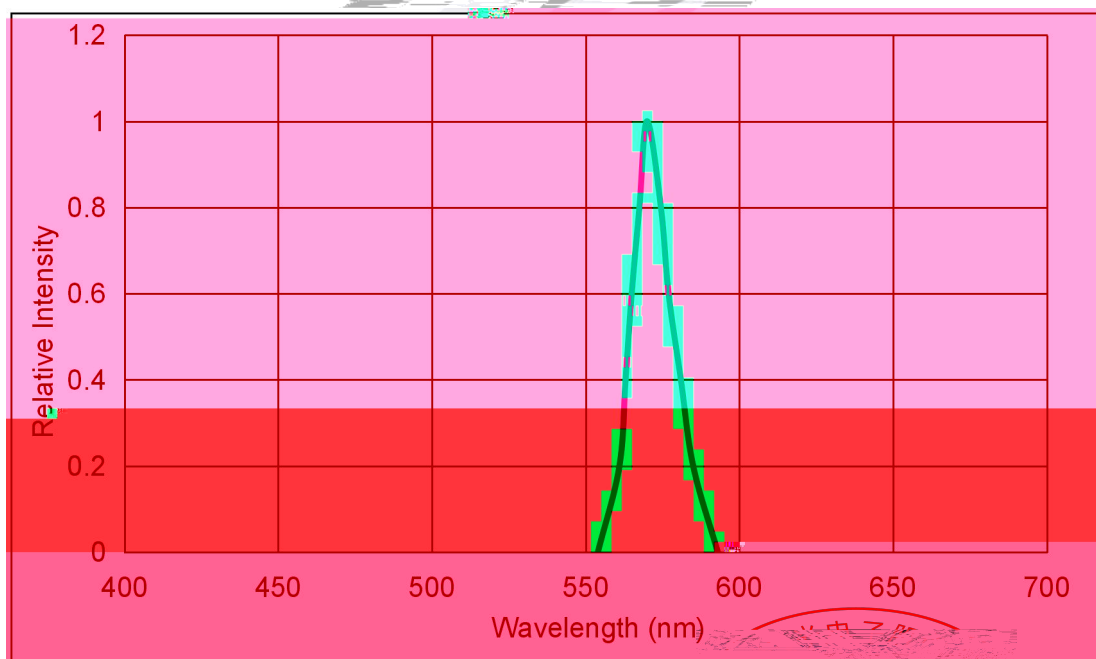
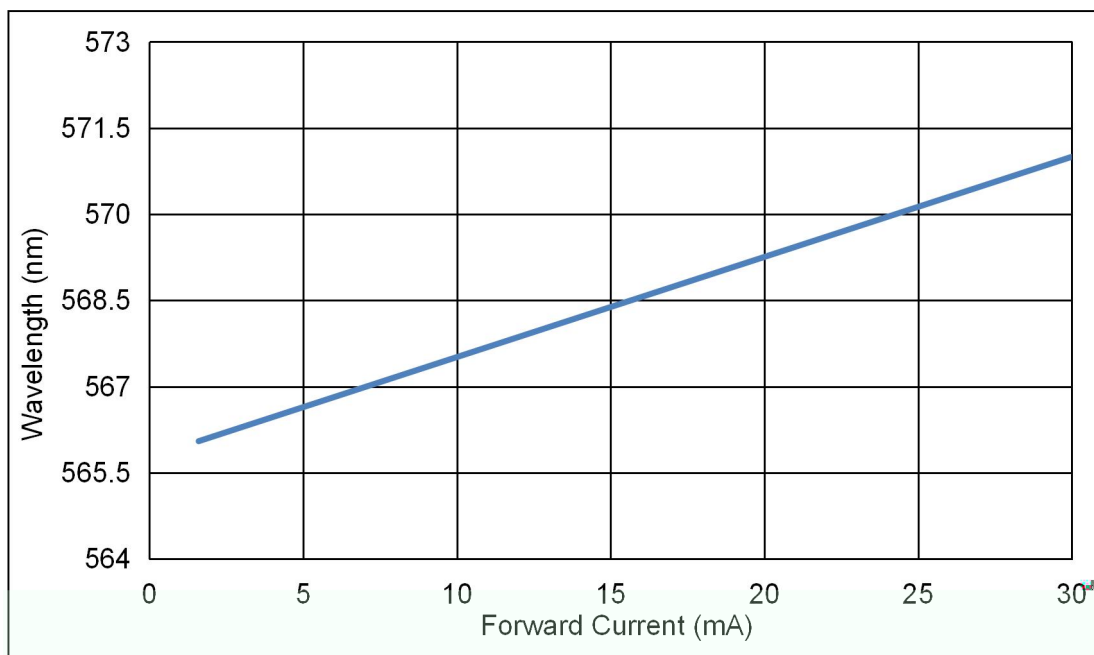

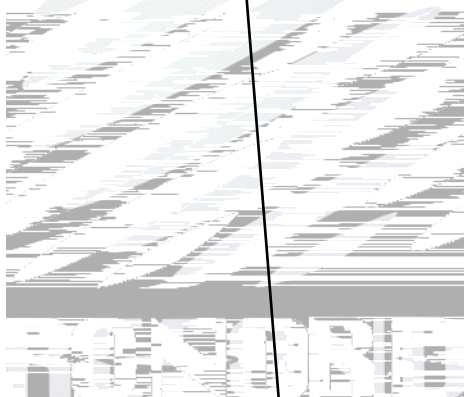
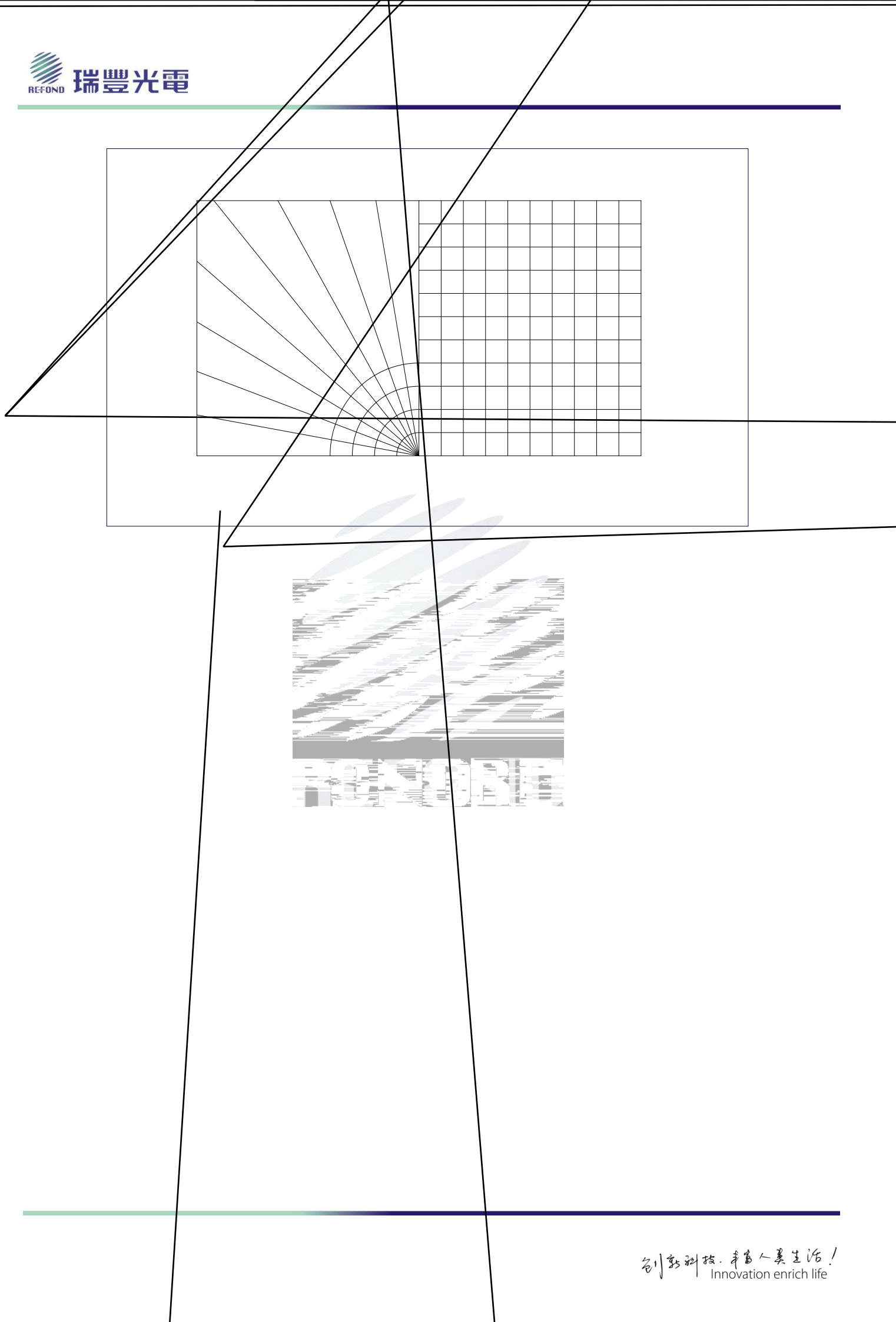

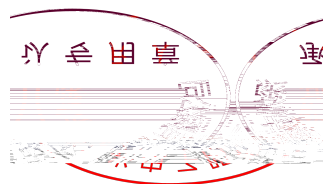

2. Packaging



2.1 Packaging Specification



PART NO:		
SPEC NO:		
LOT NO		
BIN CODE:		
Φ:	XY:	
VF:	WLD:	
	QTY:	
	DATE:	

2.2 Moisture Resistant Packing

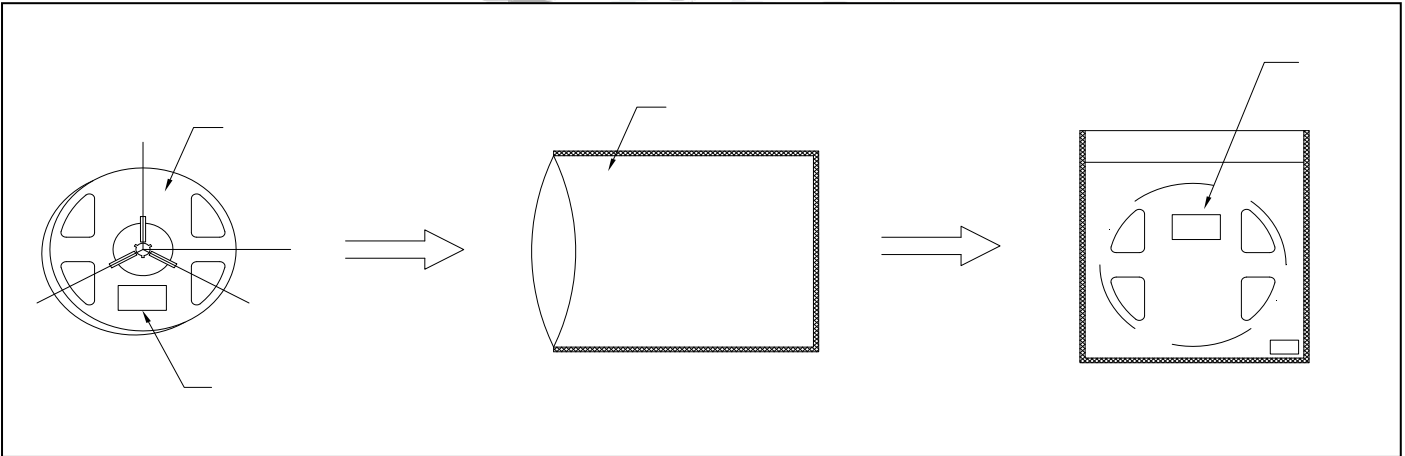

2.3 Cardboard Box

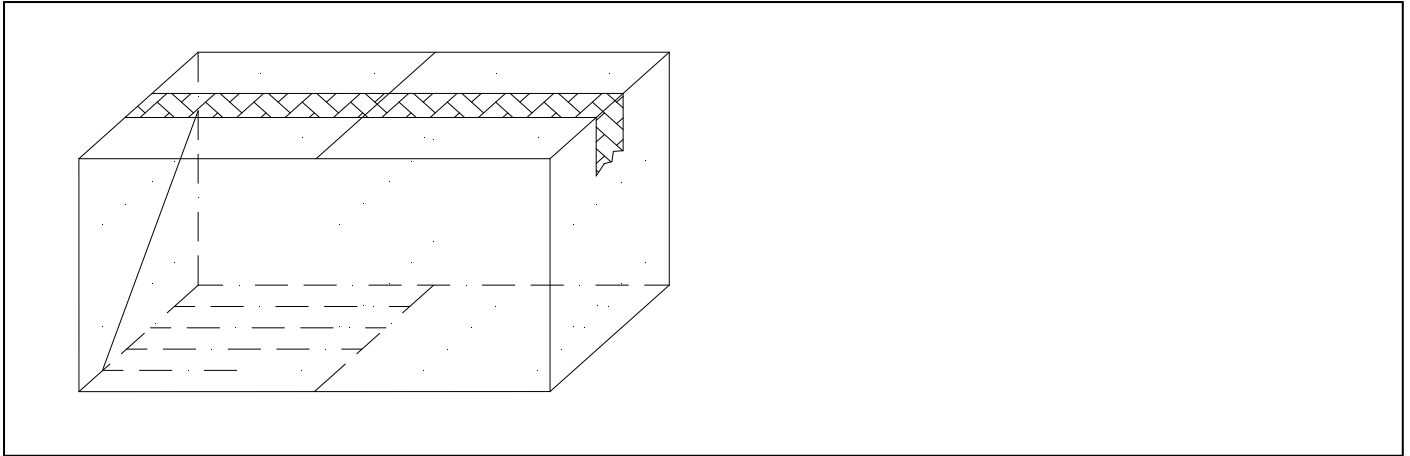

2.4 Reliability Test Items And Conditions

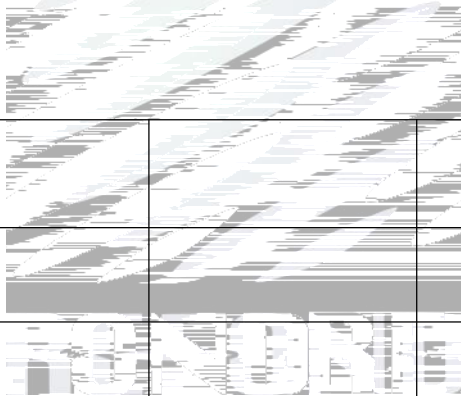

2.5 Criteria For Judging Damage

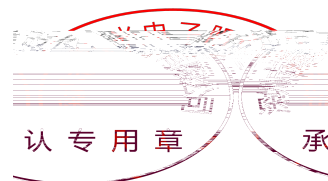

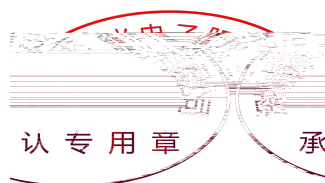

4. Handling Precautions

4.1 Handling Precautions

