

# SPECIFICATION

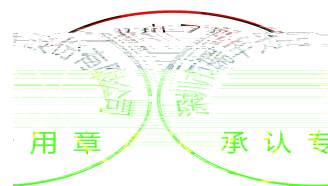

## Contents

1. Description	.....	3
1.1 General Description	.....	3
1.2 Features	.....	3
1.3 Application	.....	3
1.4 Package Dimension	.....	4
1.5 Product Parameters	.....	5
1.6 Bin Range Of Luminous Flux (IF=20mA)	BIN (IF=20mA) .....	6
1.7 Typical Optical Characteristics Curves	.....	8
2. Packaging	.....	11
2.1 Packaging Specification	.....	11
2.1.1 Suction box Dimension	.....	11
2.1.2 Label Form Specification	.....	12
2.2 Moisture Resistant Packing	.....	12
2.3 Cardboard Box	.....	13
2.4 Reliability Test Items And Conditions	.....	13
2.5 Criteria For Judging Damage	.....	14
3. Handling Precautions	.....	15

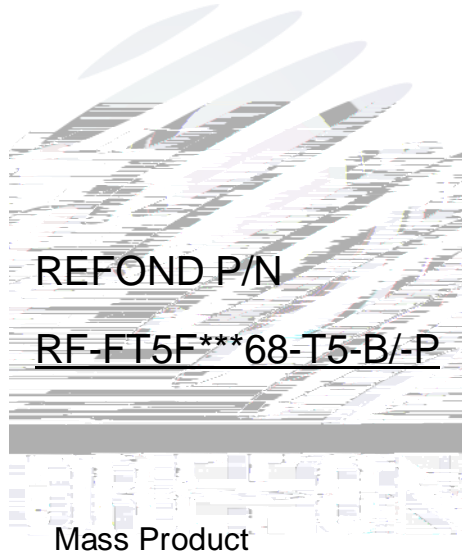
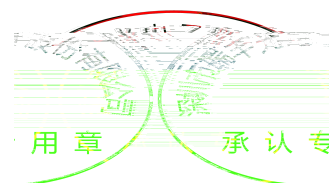

## 1. Description

### 1.1



The White LED, which was fabricated by using a blue chip and the phosphor.

Product Package:53.0mm×1.5mm×2.2mm.

LED

53.0mm×1.5mm×2.2mm

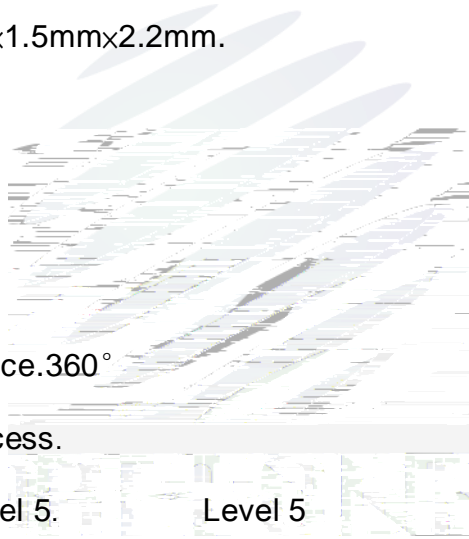

### 1.2 Features

- ▶ Integrated Package.
- ▶ 360 ° Full Angle Luminescence.360°
- ▶ Suitable for spot welding process.
- ▶ Moisture sensitivity level: Level 5. Level 5
- ▶ RoHS compliant. RoHS

### 1.3 Application

- ▶ Indoor lighting.
- ▶ Decorative applications.
- ▶ General use.

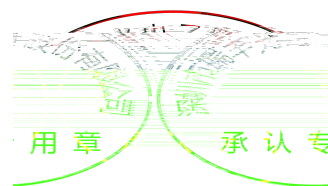

### 1.4 Package Dimension

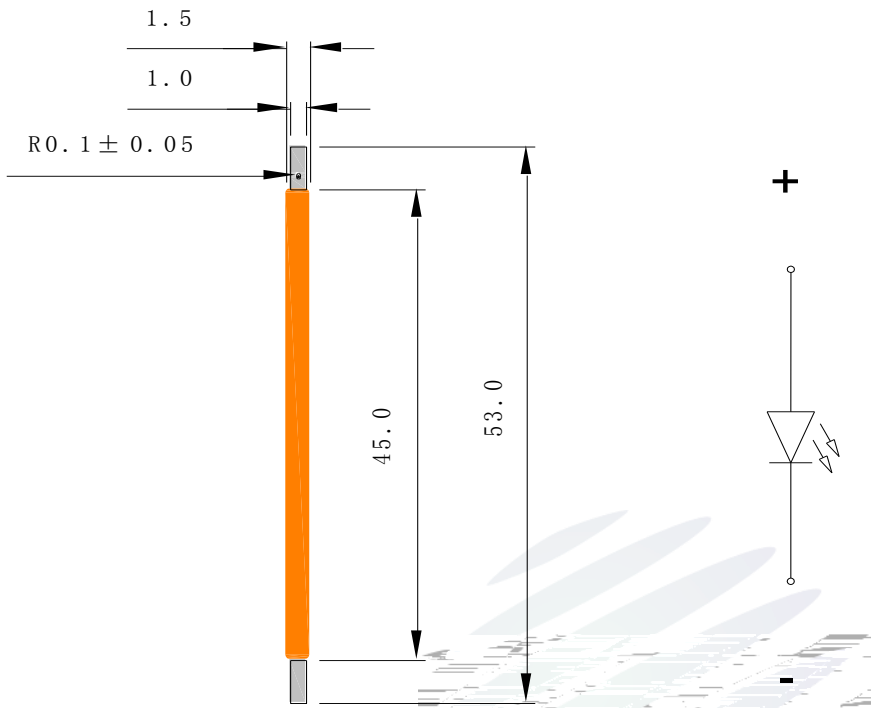

Fig.1-1 Top View

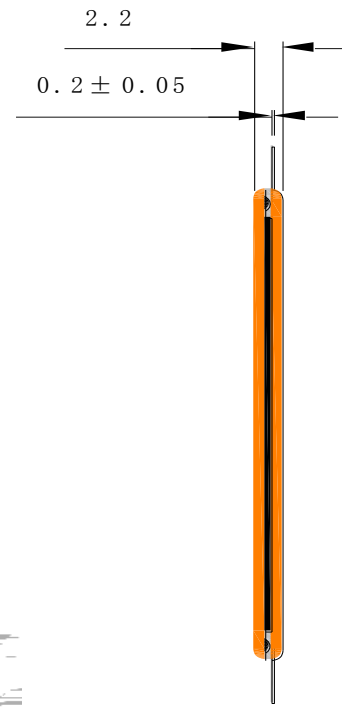

Fig.1-2 Side View



Fig.1-3 Whole Line View

Notes

1. All dimensions units are millimeters.
2. All dimensions tolerances are  $\pm 0.5\text{mm}$  unless otherwise noted.

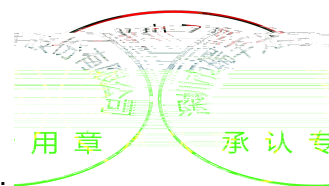

0.5

## 1.5 Product Parameters

Table 1-1 Electrical / Optical Characteristic Parameters

Item	Symbol	Test Condition	Value	
			Typ.	Max.
Forward Voltage	$V_F$	$I_F=20mA$	---	72
Leakage Current	$V_F$	$I_F=5\mu A$	50	---
Luminous Flux	$\Phi$	$I_F=20mA$	230	280
Viewing Angle	$2\theta_{1/2}$	$I_F=20mA$	---	360
Solder Temperature	$T_s$	$I_F=20mA$	---	105

 Table 1-2 Absolute Maximum Ratings at  $T_s=25^\circ C$ 

Parameter	Symbol	Units
Power Dissipation	$P_{DM}$	39.62mW

Notes



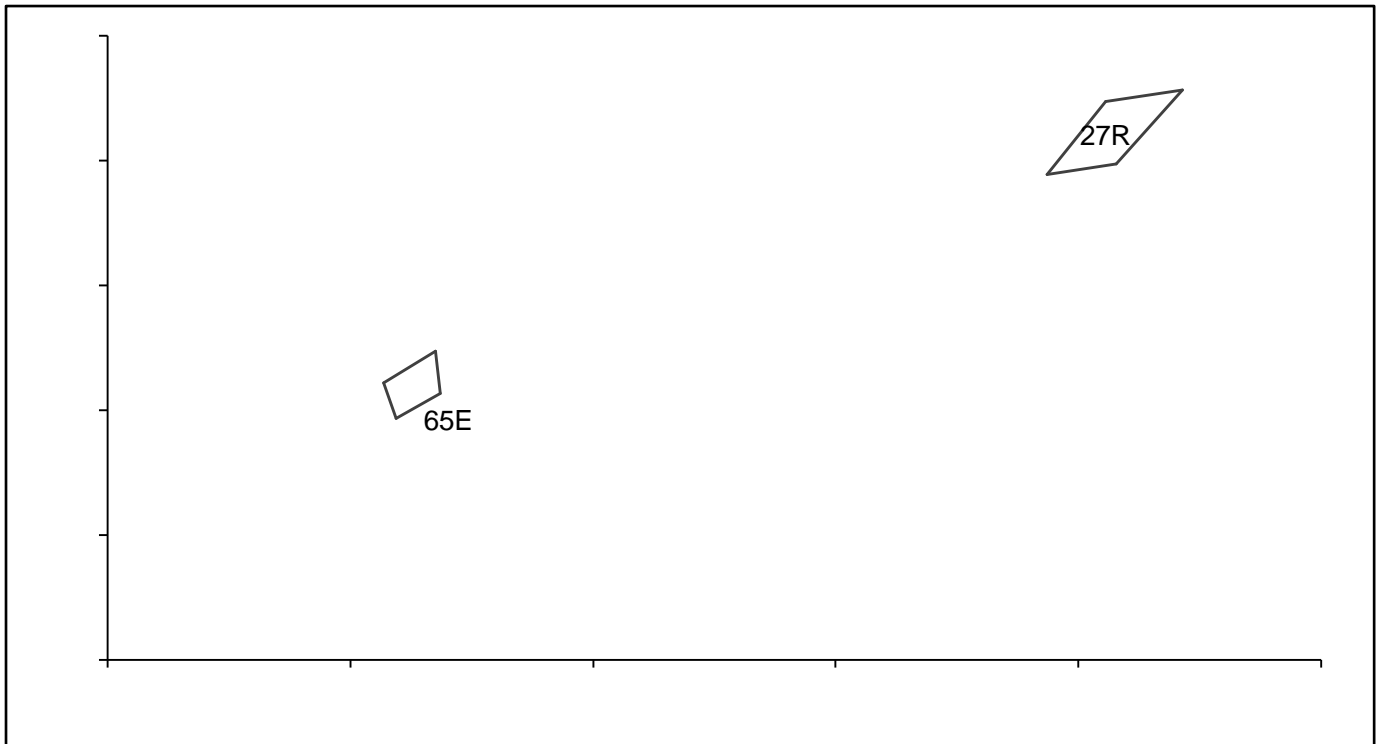
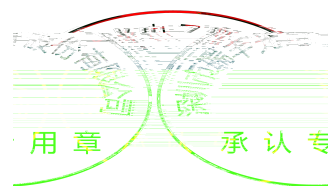

Fig. 1-6 The C.I.E Chromaticity Diagram CIE

Table 1-4

BIN CODE	CIE-X1	CIE-Y1	CIE-X2	CIE-Y2	CIE-X3	CIE-Y3	CIE-X4	CIE-Y4
27R	0.4556	0.4289	0.4715	0.4327	0.4578	0.4088	0.4435	0.4055
65E	0.3094	0.3272	0.3069	0.3387	0.3176	0.3487	0.3186	0.3354





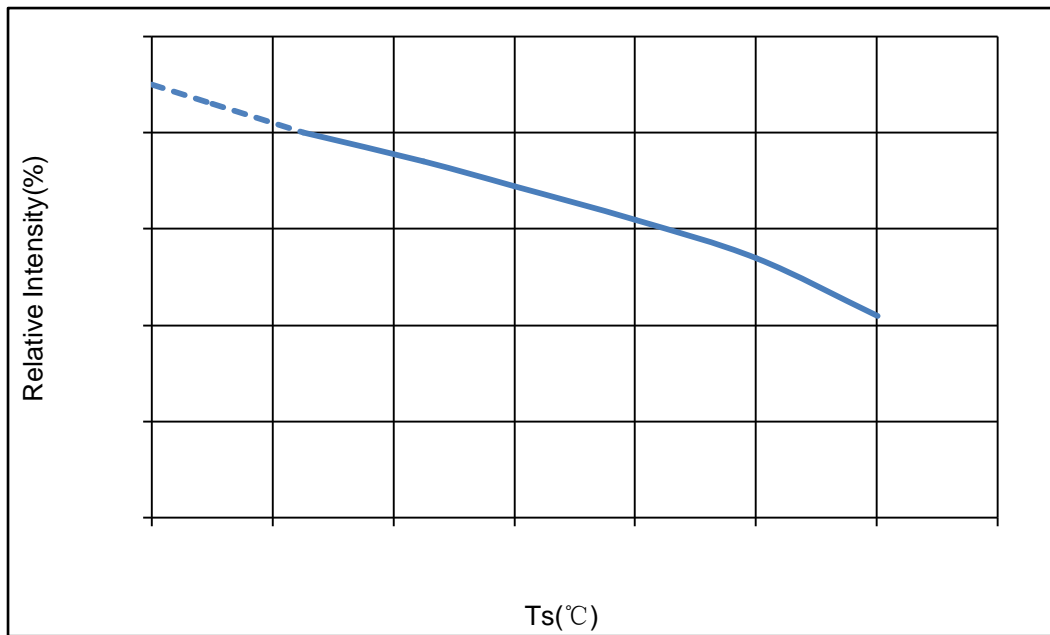

Fig. 1-9 Solder Temperature Vs Relative Intensity

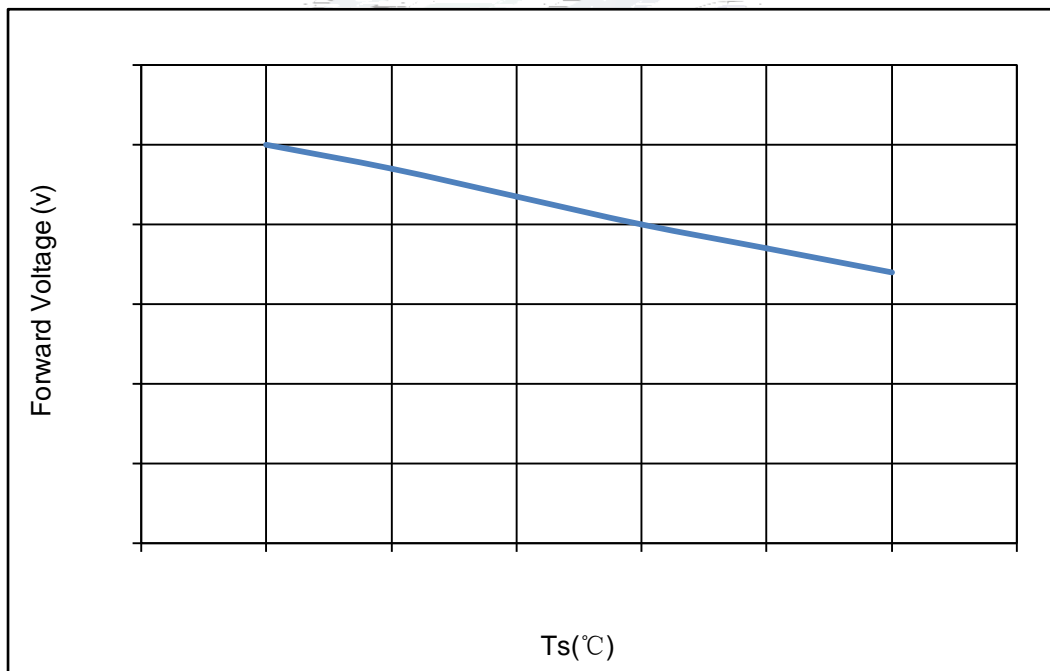
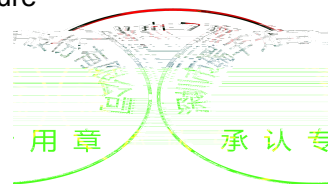

Fig. 1-10 Forward Voltage Vs Solder Temperature



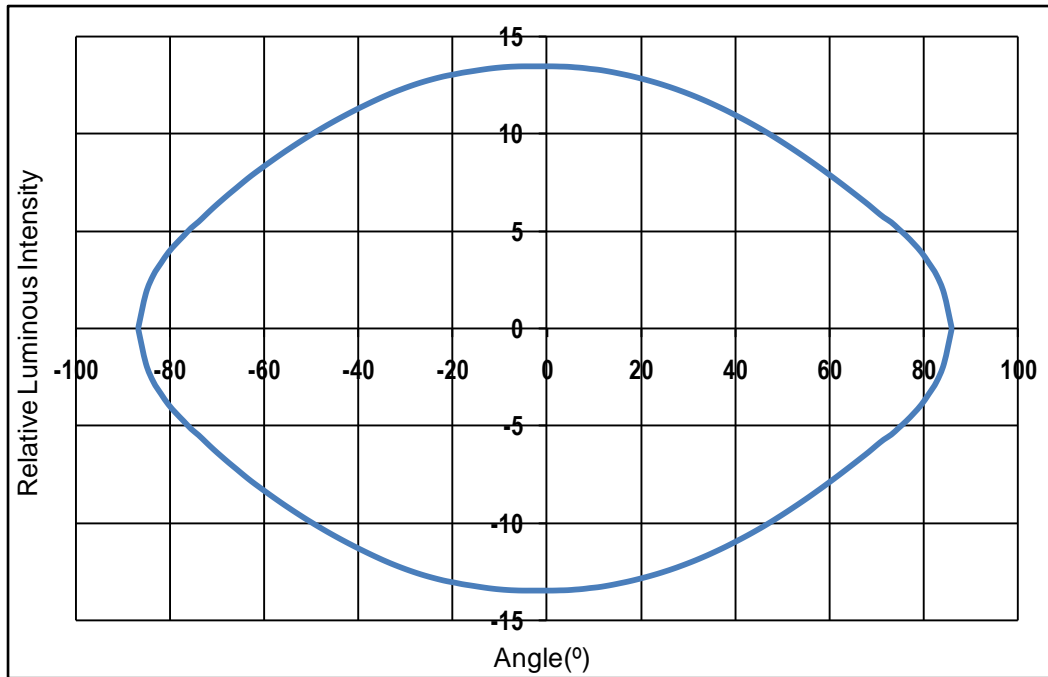

Fig. 1-11 Radiation diagram

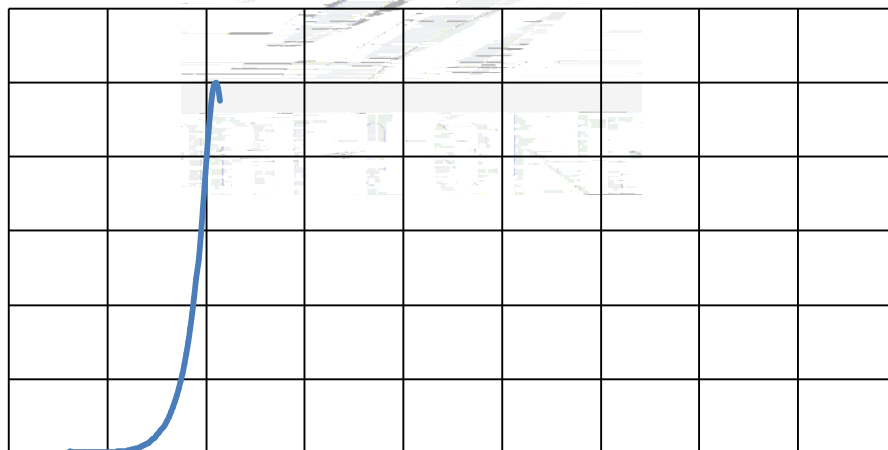

Fig. 1-12 Spectrum Distribution

## 2. Packaging

### 2.1 Packaging Specification

Single :720pcs/box	720pcs
Whole Row: 4320pcs/box	4320pcs

#### 2.1.1 Suction box Dimension

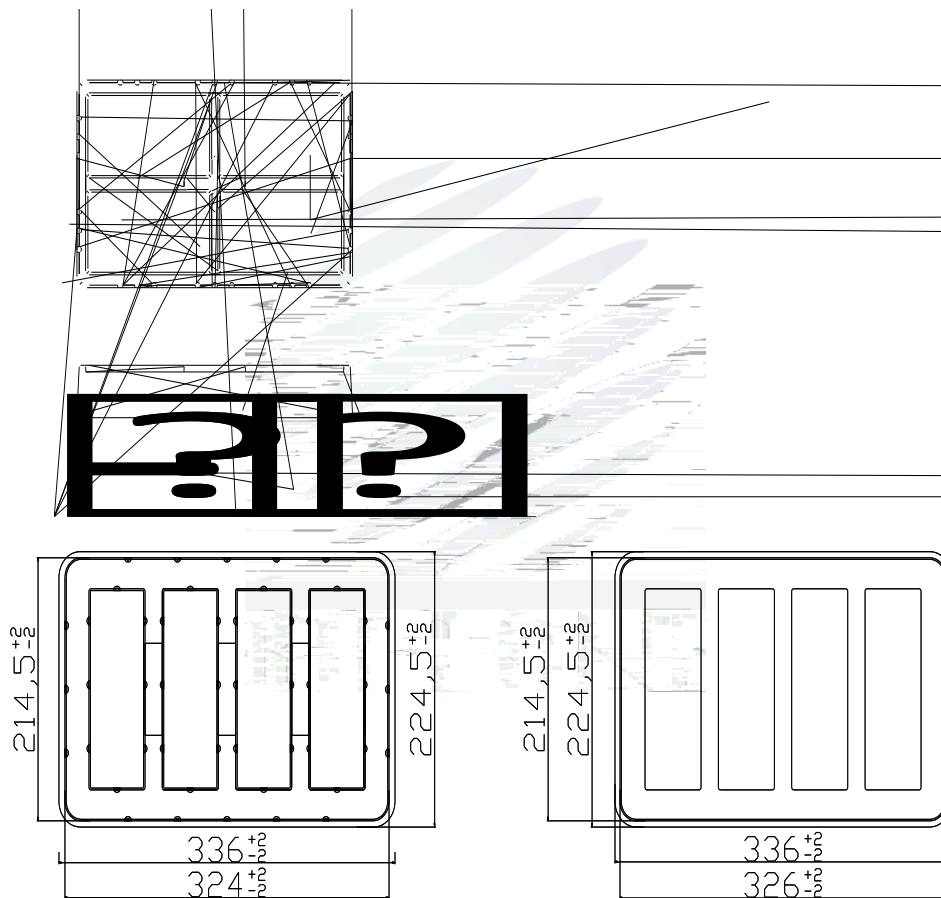
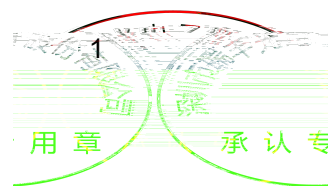

Fig.2-1 Suction box Dimension

#### Notes

The tolerances unless mentioned  $\pm 0.1$ mm. Unit : mm



## 2.1.2 Label Form Specification

Table 2-1 Title

PART NO.	Part Number
SPEC NO.	Spec Number
LOT NO.	Lot Number
BIN CODE	

Fig. 2-2 Label

## 2.2 Moisture Resistant Packing

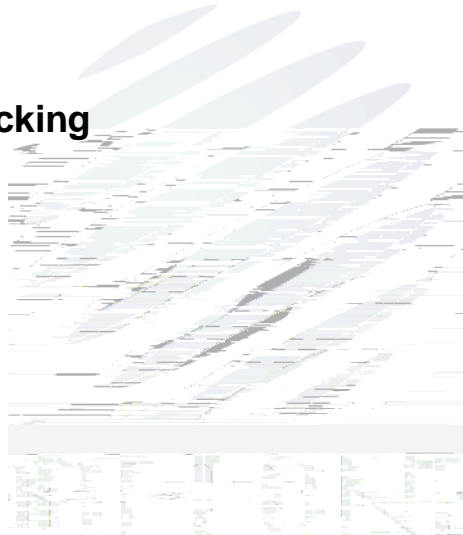

Fig.2-3 Moisture Resistant Packing

## 2.3 Cardboard Box

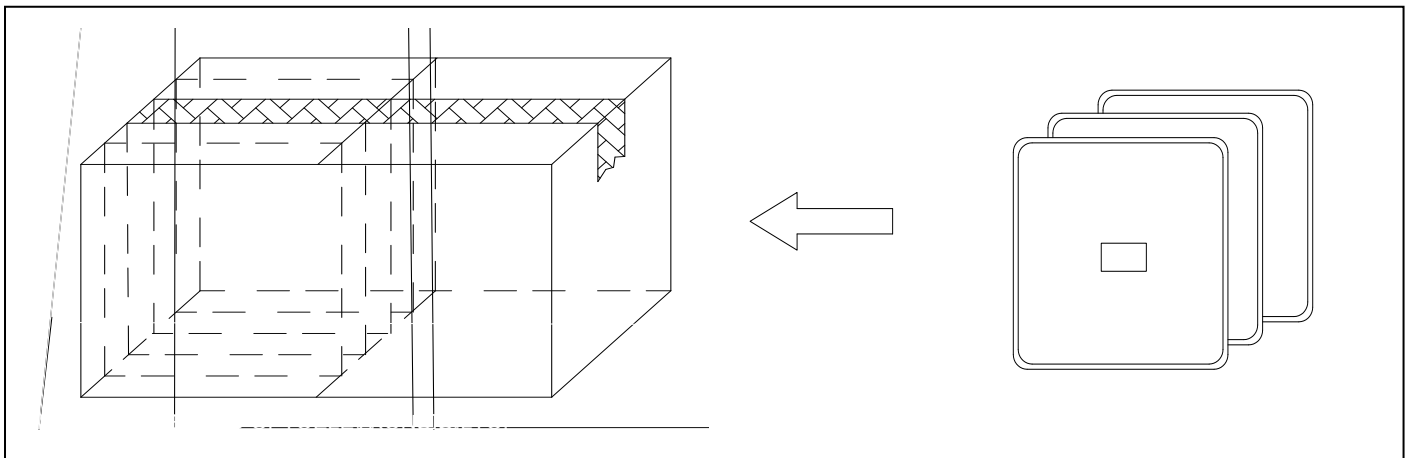

Fig.2-4 Cardboard Box

## 2.4 Reliability Test Items And Conditions

Table 2-2 Reliability Test Items And Conditions

Test Items	Ref.Standard	Test Condition	Time	Quantity	Ac/Re /
Thermal Shock	JEITAED-4701 300307	-40 15min ↑↓10s 100 15min	100 cycle	20pcs	0/1
Switching Test	/	25°C, On 2.5min ↑↓ Off 2.5min	2500cycle	20pcs	0/1
Life Test	JESD22-A108	Ta=25 If=20mA	1000hrs	10pcs	0/1
High Temperature High Humidity Life Test	JESD22-A101	60 / 90%RH If=20mA	500hrs	10pcs	0/1

用章 承认专

## 2.5 Criteria For Judging Damage

Table 2-3 Criteria For Judging Damage

Test Items	Symbol	Test Condition	Criteria For Judgement	
			Min.	Max.
Forward Voltage	$V_F$	$I_F=20mA$	-	Forward Voltage
Luminous Flux	$\Phi$	$I_F=20mA$	L.S.L*)x0.7	Luminous Flux

### Notes

- 1.U.S.L: Upper standard level      L.S.L: Lower standard level
2. The above reliability tests is based on the verification of a single/strip LED of Refond's existing experimental platform, the reliability experiment was taken under good heat dissipation conditions. when customers applies the LED to the series and parallel circuit, should take consideration of all the factors such as the current, voltage distribution, heat dissipation and others. / LED
- 3.The technical information shown in the data sheets is limited to the typical characteristics and circuit examples of the referenced products. It does not constitute the warranting of industrial property nor the granting of any license.

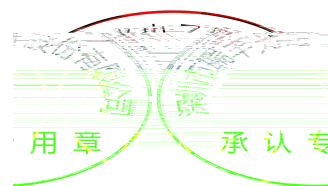

### 3. Handling Precautions

(1) LED operating environment and sulfur element composition cannot be over 100PPM in the LED mating usage material. This is provided for informational purposes only and is not a warranty or endorsement. LED LED 100PPM.

(2) In order to prevent external material from getting into the inside of LED, which may cause the malfunction of LED, the single content of Bromine element is required to be less than 900PPM, the single content of Chlorine element is required to be less than 900PPM, the total content of Bromine element and Chlorine element in the external materials of the application products is required to be less than 1500PPM. This is provided for informational purposes only and is not a warranty or endorsement. LED LED

900PPM 900PPM  
1500PPM.

(3) VOCs (Volatile organic compounds) emitted from materials used in the construction of fixtures can penetrate silicone encapsulants of LEDs and discolor when exposed to heat and photonic energy. The result can be a significant loss of light output from the fixture. Knowledge of the properties of the materials selected to be used in the construction of fixtures can help prevent these issues. Refond advises against the use of any chemicals or materials that have been found or are suspected to have an adverse affect on device performance or reliability. To verify compatibility, Refond recommends that all chemicals and materials be tested in the specific application and environment for which they are intended to be used. Attaching LEDs, do not use adhesives that outgas organic vapor. LED

LED

LED

LED

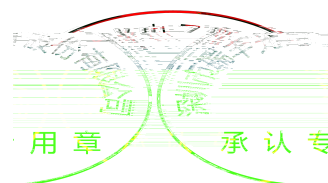

(4) Handle the component along the side surface by using forceps or appropriate tools; Do not directly touch or Handle the silicone lens surface, it may damage the internal circuitry.

(5) In designing a circuit, the current through each LED can not exceed the absolute maximum rating specified for each LED. In the meanwhile, resistors for protection should be applied, otherwise slight voltage shift will cause big current change, burn out may happen. The driving circuit must be designed to allow forward voltage only when it is ON or OFF. If the reverse voltage is applied to LED, migration can be generated resulting in LED damage. LED

LED (ED) TJ ET EMC /P <</MCID 1457e W270.12F6 11.846397C48>-29<

## LED

Table 4-1 Storage

Conditions		Temperature	Humidity	Time
Storage 儲存	Before Opening Aluminum Bag	30	75%	Within 1 Year From Date
	After Opening Aluminum Bag	30	60%	24hours 24
Baking		60 ± 5		24hours 24

(8) If the moisture absorbent material ( silica gel ) has faded away or the LEDs have exceeded the storage time, baking treatment should be performed after unpacking and based on the following condition ( 65±5 ) °C for above 24 hours.

60 ± 5      24

If the package is flatulence or damaged, please notify the sales staff to assist.

(9) Similar to most Solid state devices; LEDs are sensitive to Electro-Static Discharge (ESD) and Electrical Over Stress (EOS).

## LED

(10) Other points for attention, please refer to our relevant information.

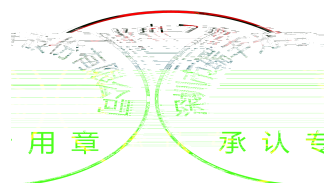



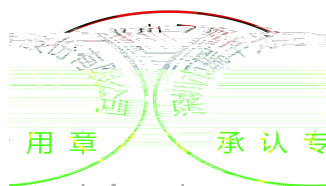

Declare

This specification is written both in English and in Chinese and the latter is formal.