

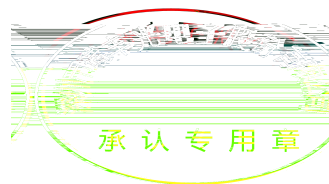

3  
3  
3  
3  
4  
5  
7  
11  
11  
12  
13  
13  
14  
15  
15  
17  
17

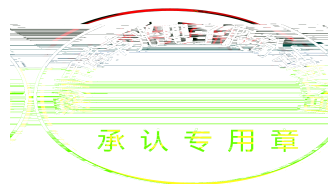

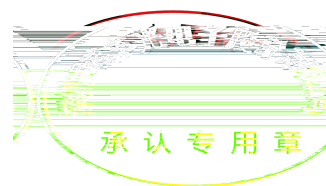

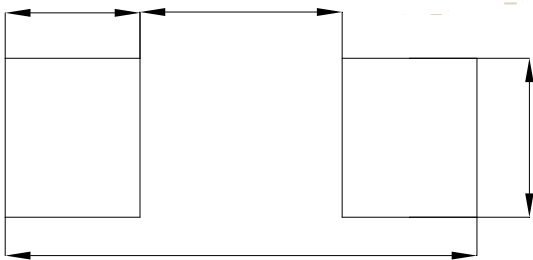
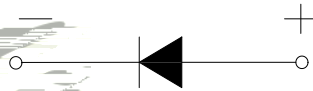
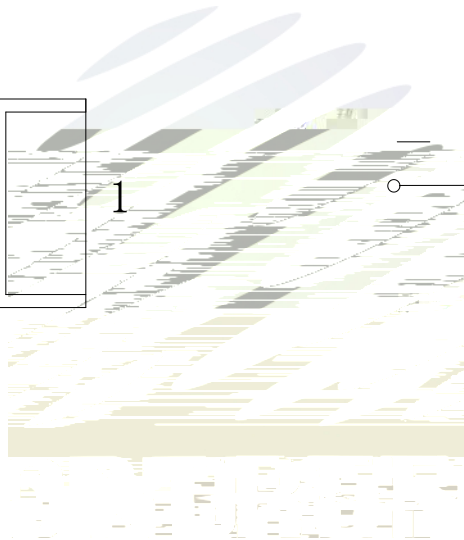
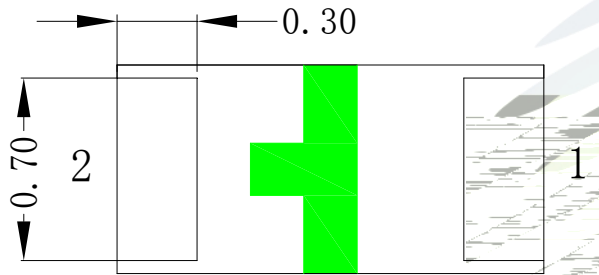
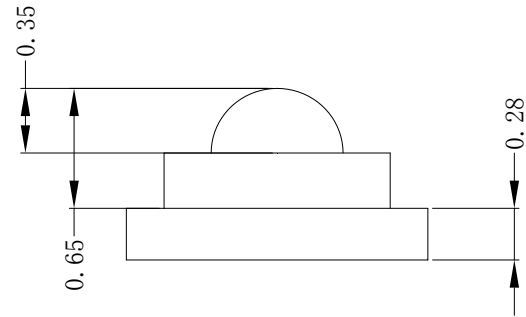
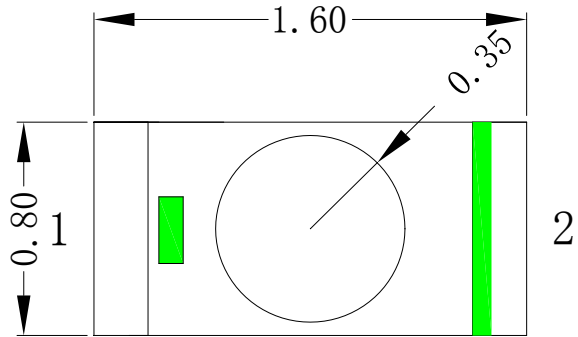

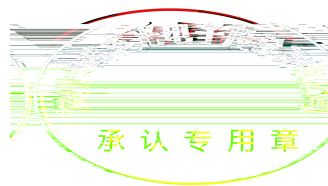

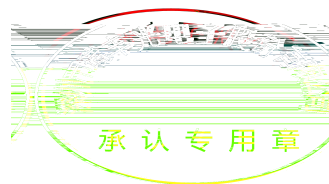

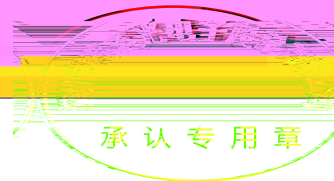
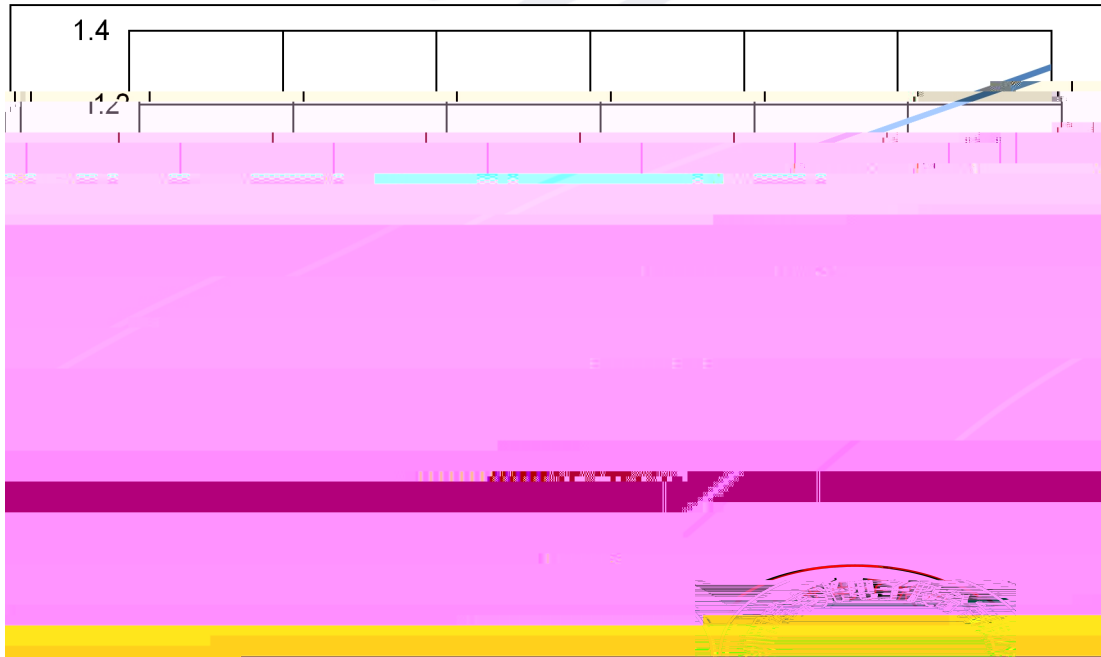
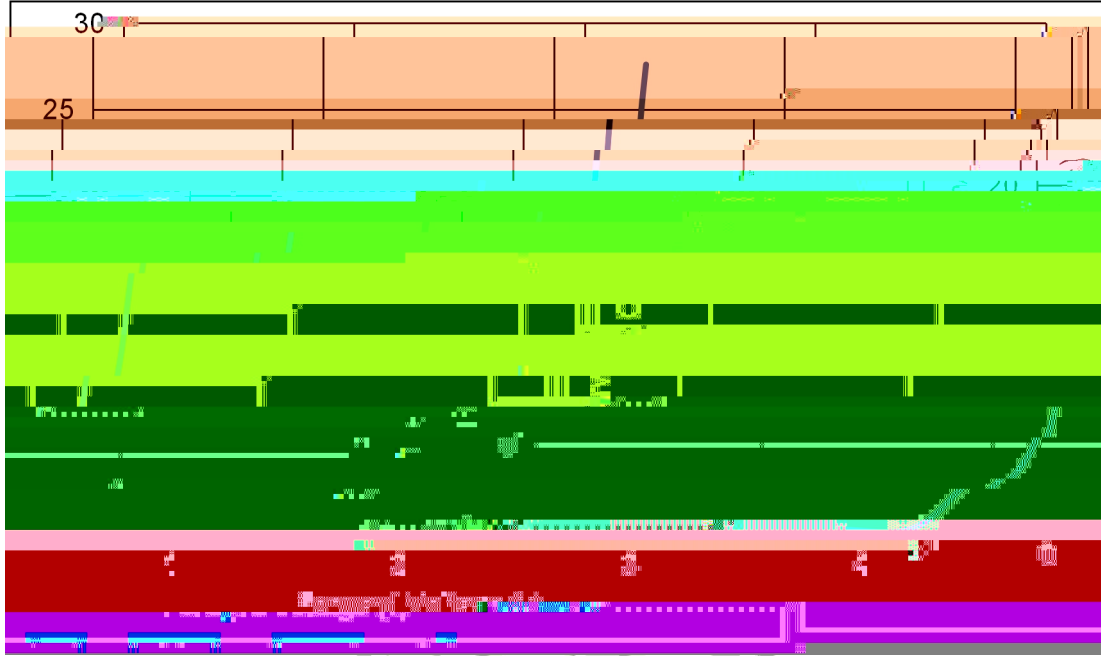

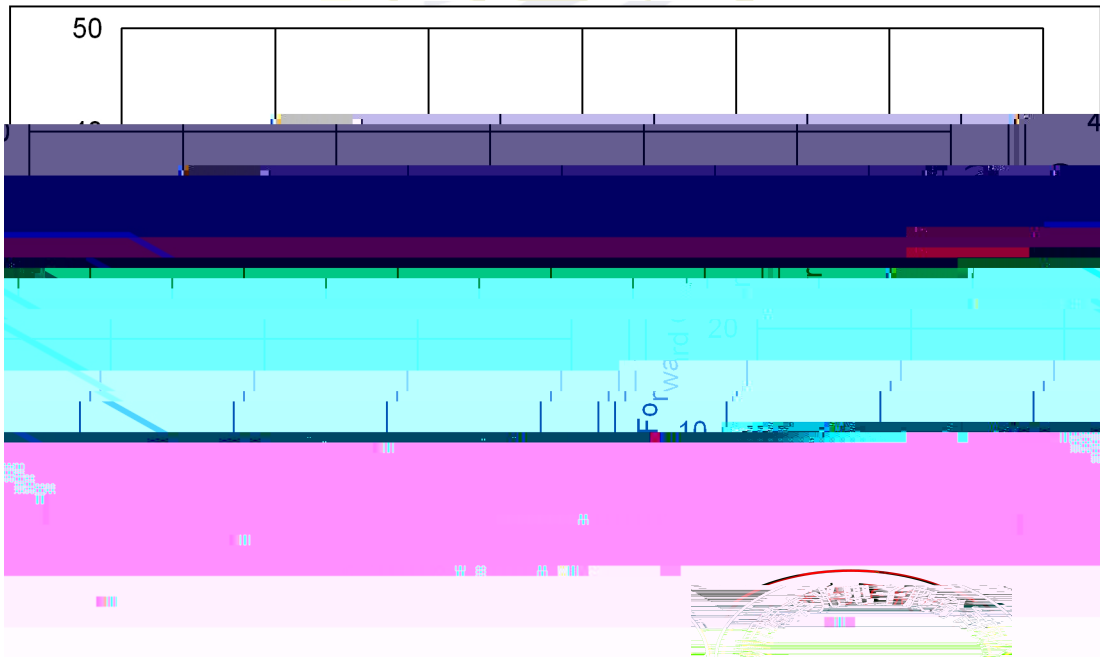
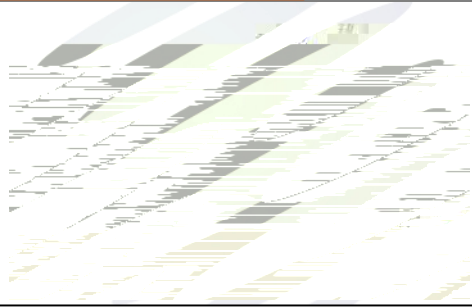
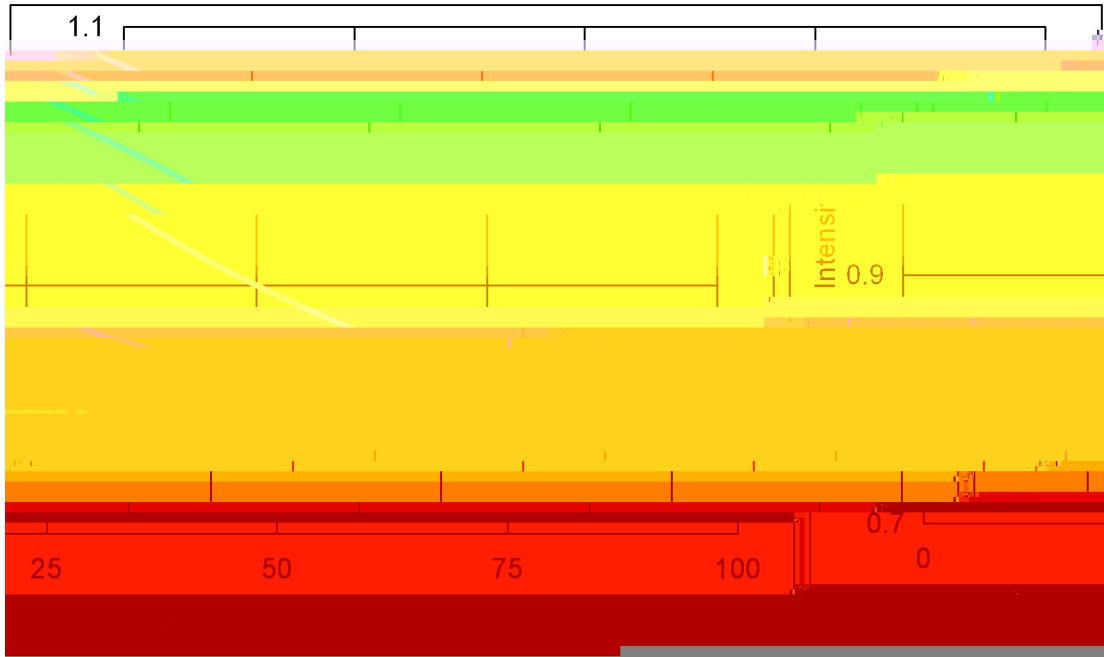

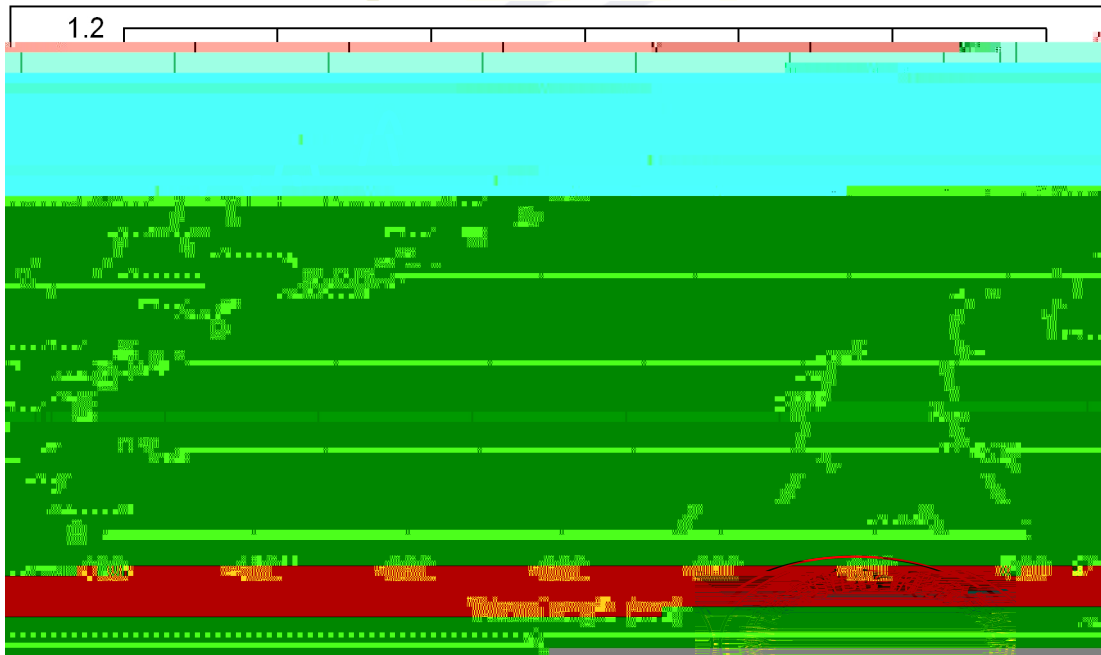
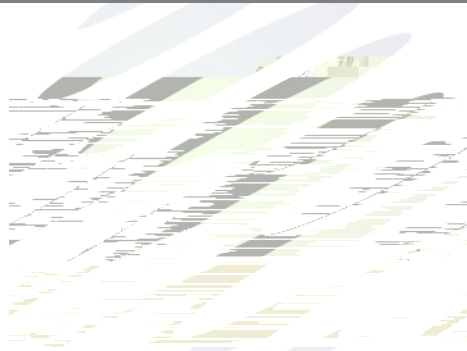
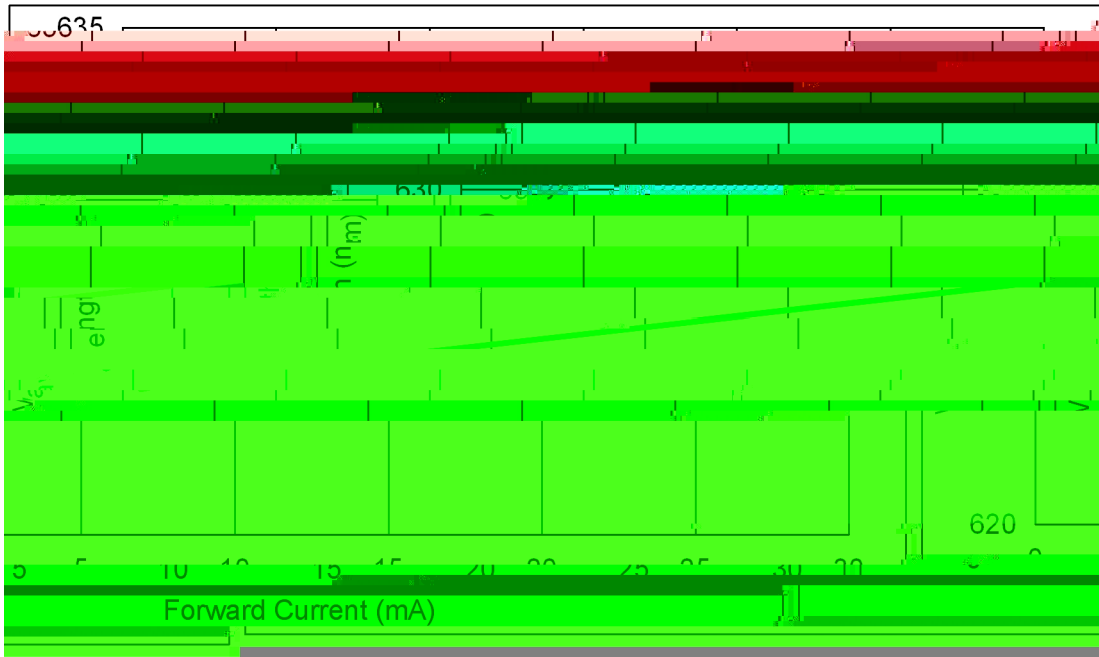

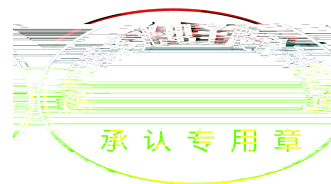
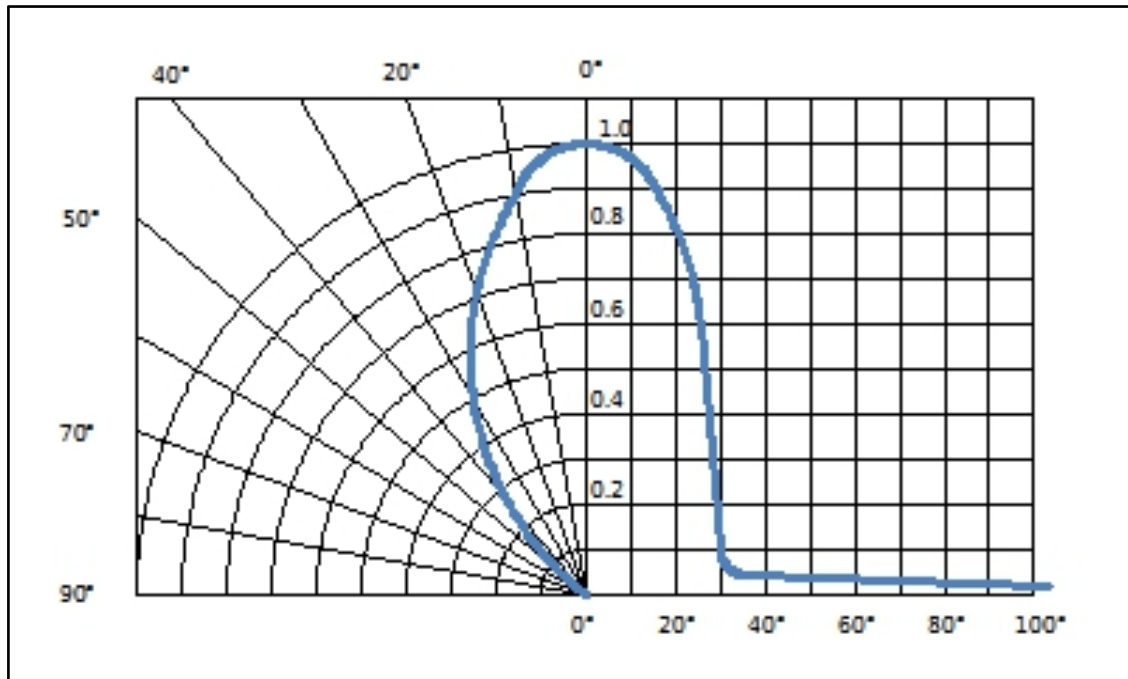

承认专用章





PART NO:  
SPEC NO:  
LOI NO:  
BIN CODE:  
IV:  
VF:  
WLD:  
Qty:  
Date:



---

---

---

---

---

---

---

---

