

..... 3

..... 3

..... 3

..... 3

..... 4

..... 5

..... 7

..... 8

..... 12

..... 12

..... 12

..... 12

..... 13

..... 13

..... 14

..... 14

..... 15

..... 16

..... 16

..... 18

..... 18

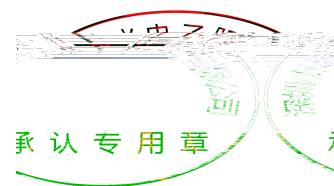
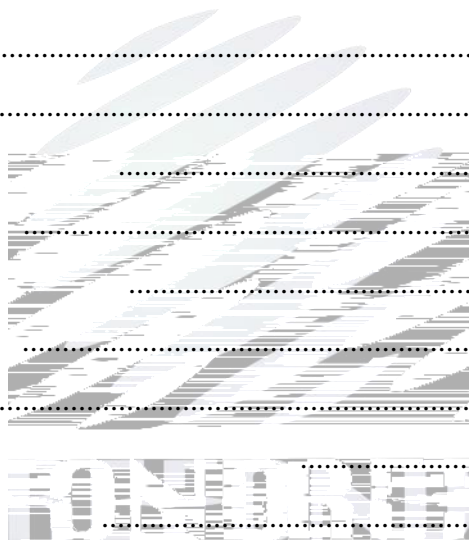

1.

1.1

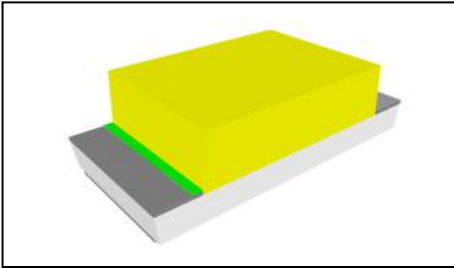

1.2



1.3

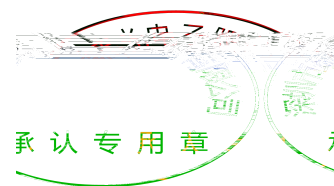



| | | | |
|--|--|--|--|
| | | | |
| | | | |
| | | | |
| | | | |
| | | | |
| | | | |
| | | | |
| | | | |
| | | | |
| | | | |

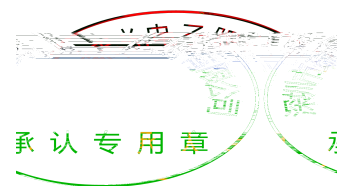
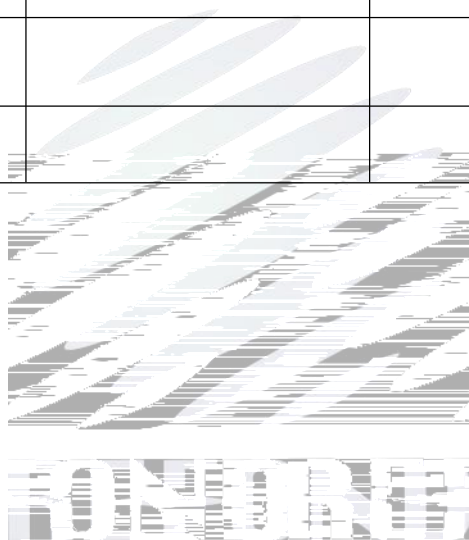

1. —

(20)

(20)



1.



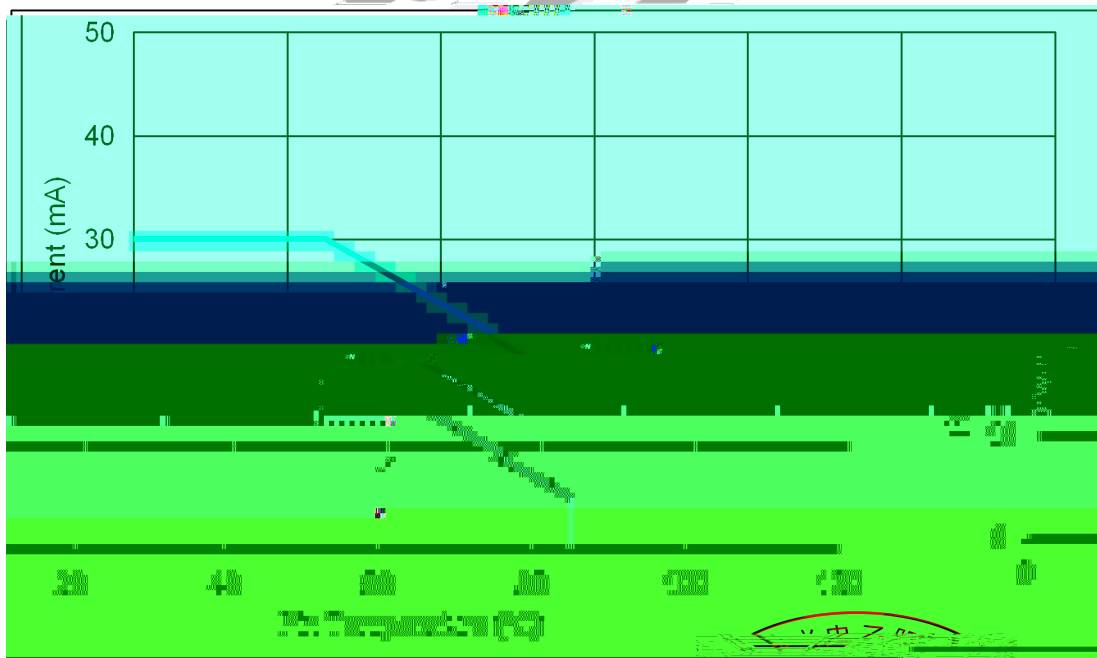
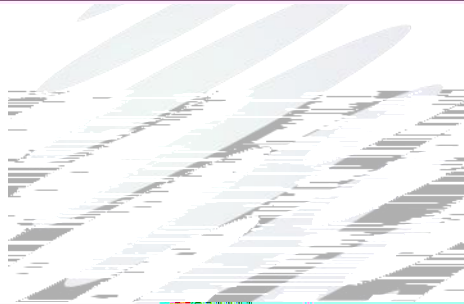
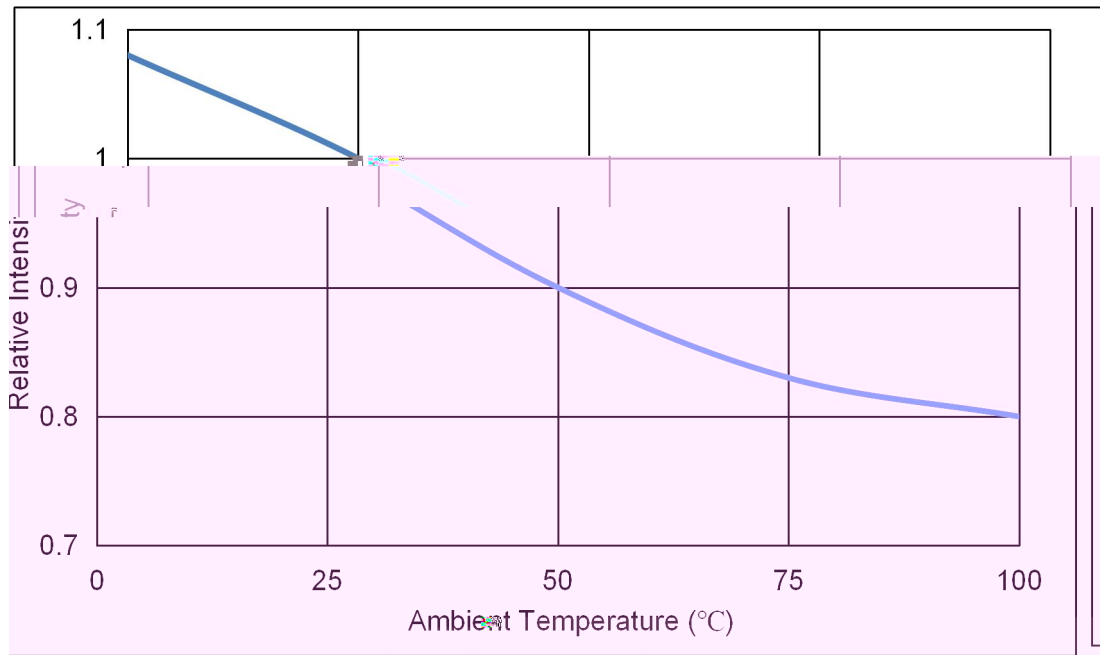

承认专用章

瑞豐光電

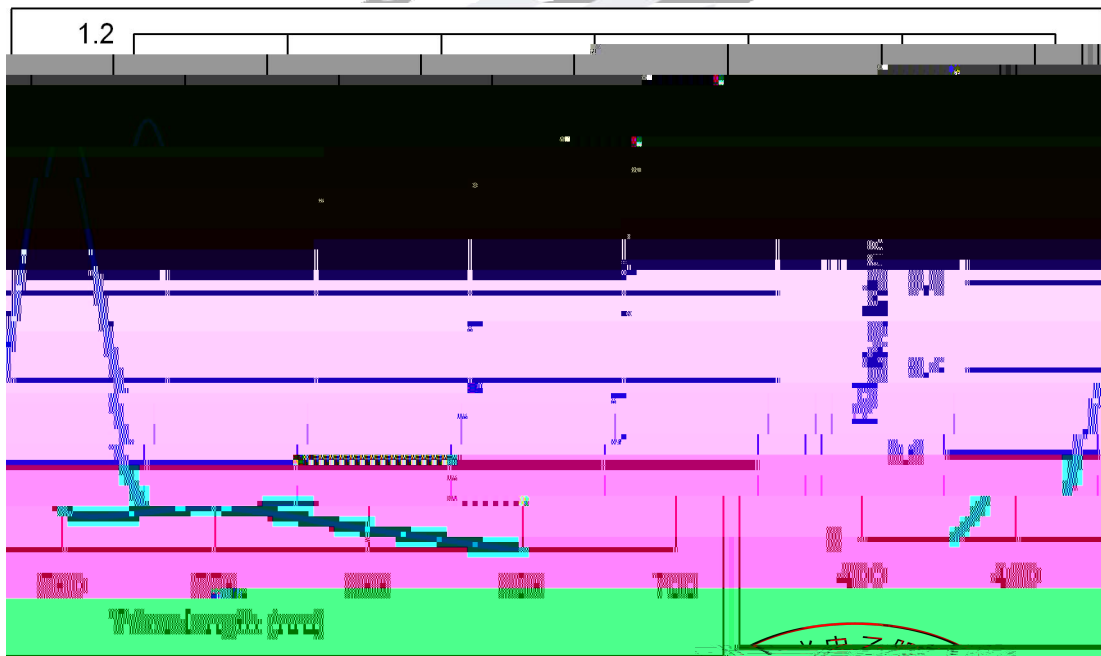
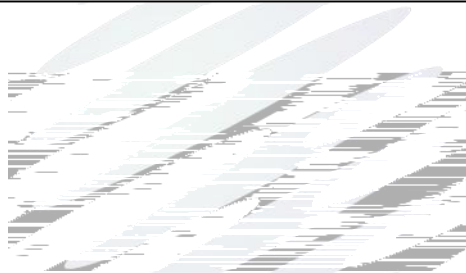
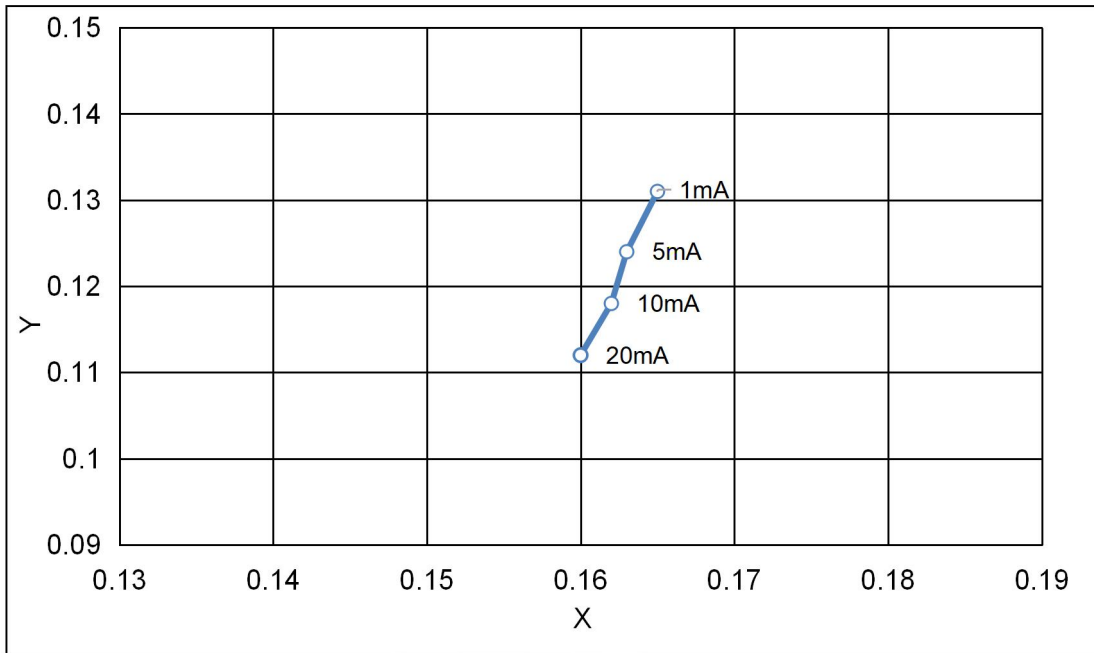

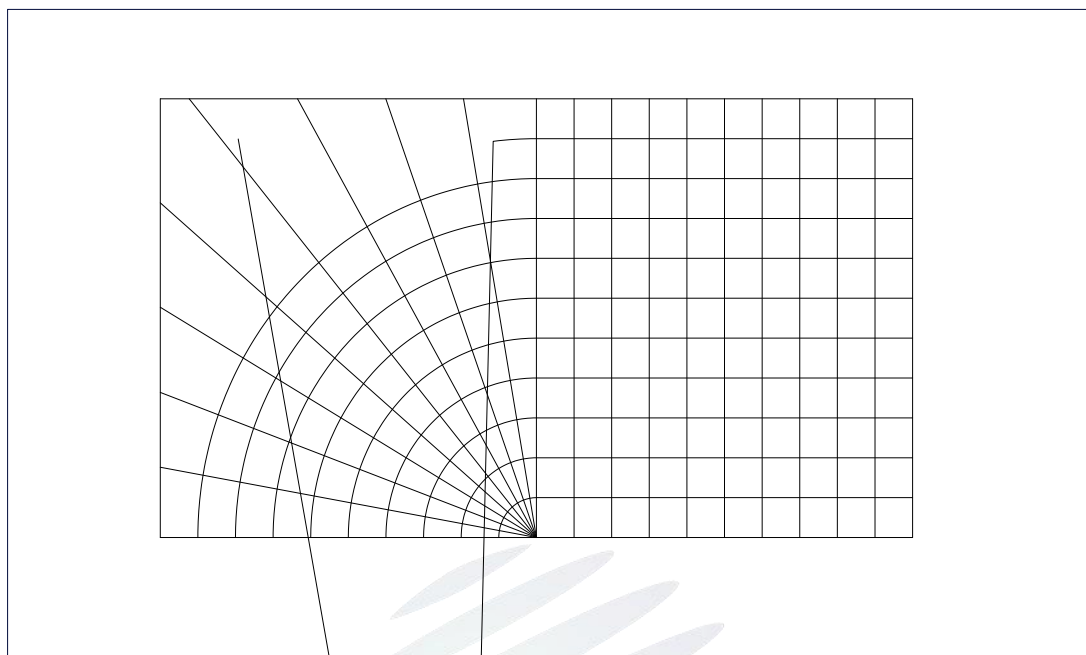

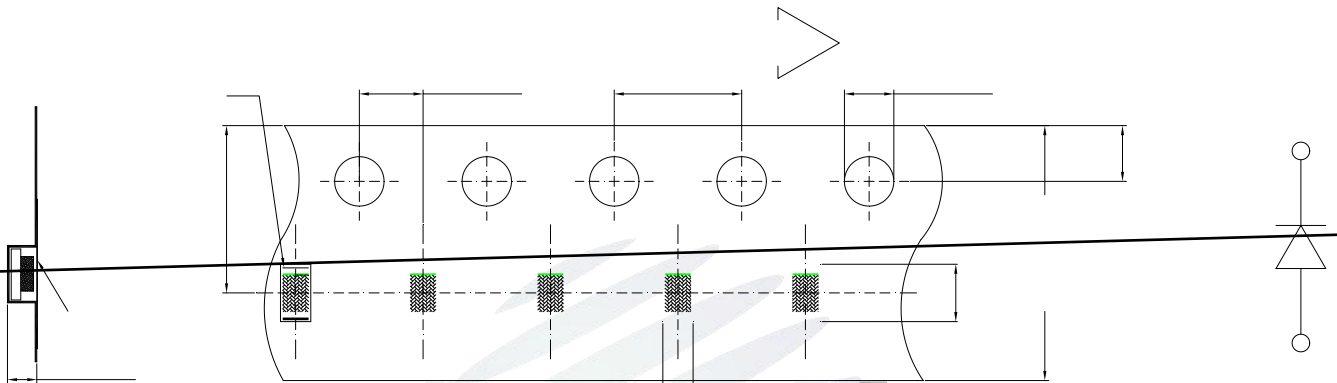

2.2

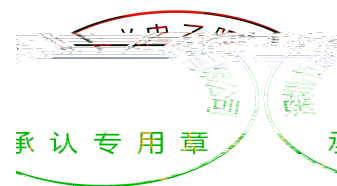
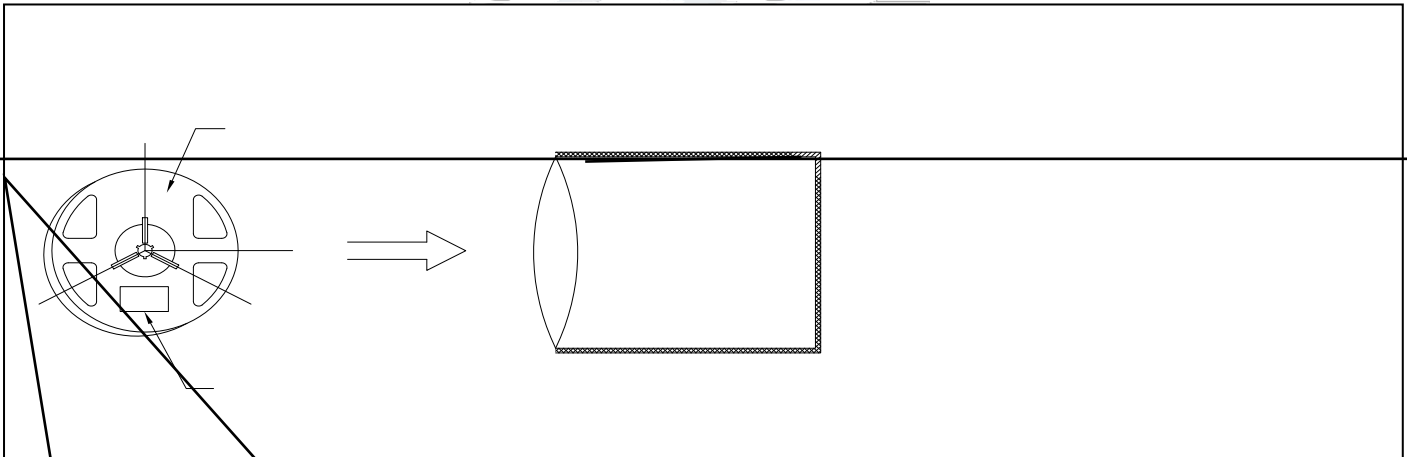

3

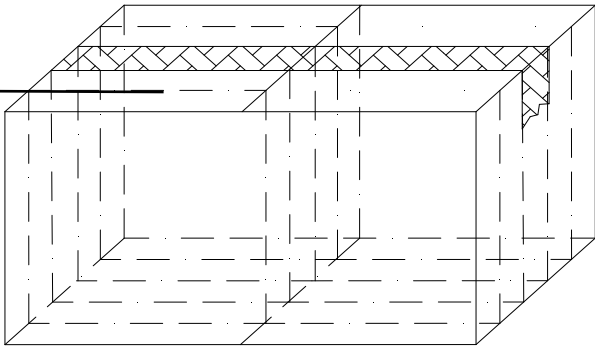

4



| | | | | | |
|--|--|--|--|--|--|
| | | | | | |
| | | | | | |
| | | | | | |
| | | | | | |
| | | | | | |
| | | | | | |
| | | | | | |
| | | | | | |
| | | | | | |
| | | | | | |

2.5

| | | | | |
|--|--|--|------|--|
| | | | | |
| | | | Min. | |
| | | | | |
| | | | | |
| | | | | |

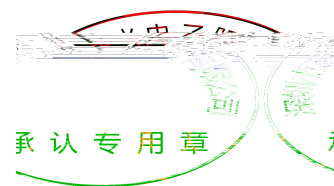

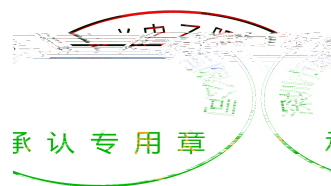

4. 目錄

4.1 目錄

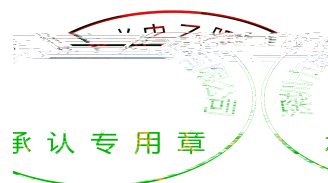



| | | | |
|--|--|--|--|
| | | | |
| | | | |
| | | | |
| | | | |

