

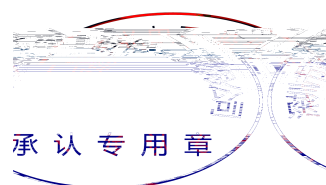

3
3
3
3
4
5
7
11
11

12
13
13
14
15
15
17
17

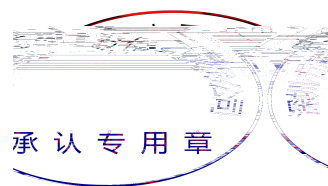

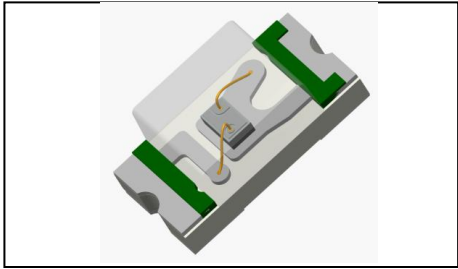

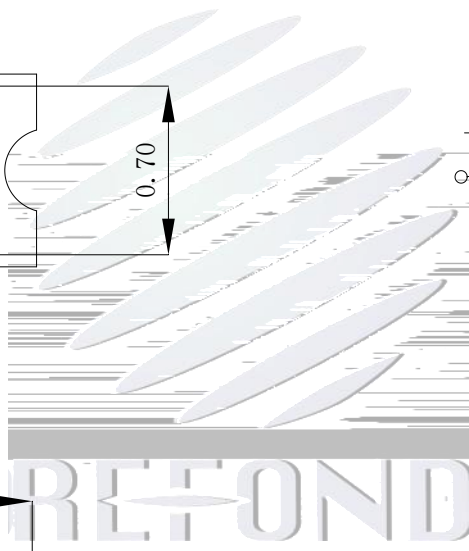
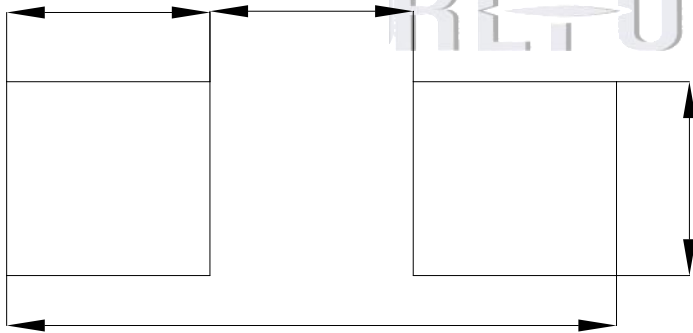
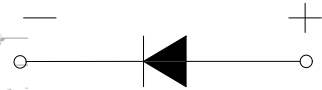
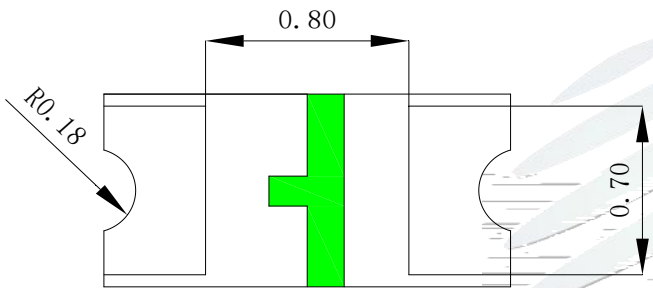
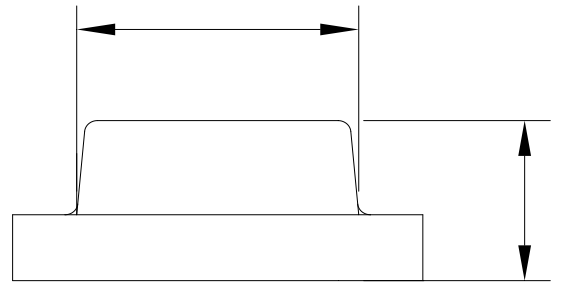
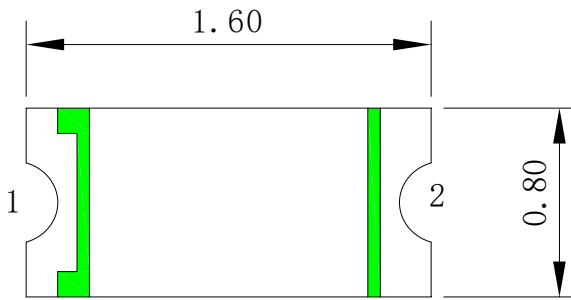

2.

±

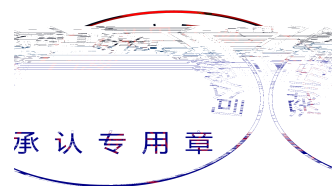

			°C
			°C
			°C

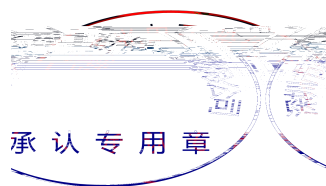
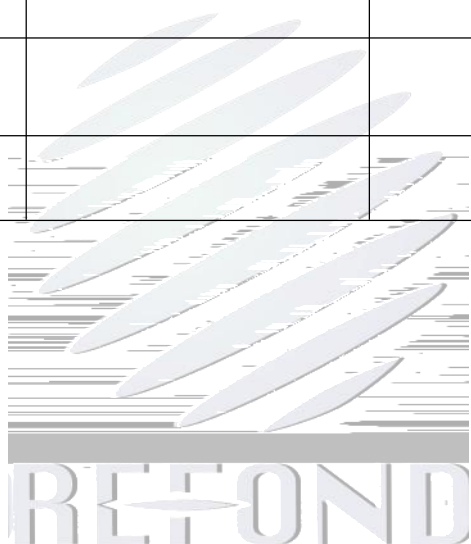

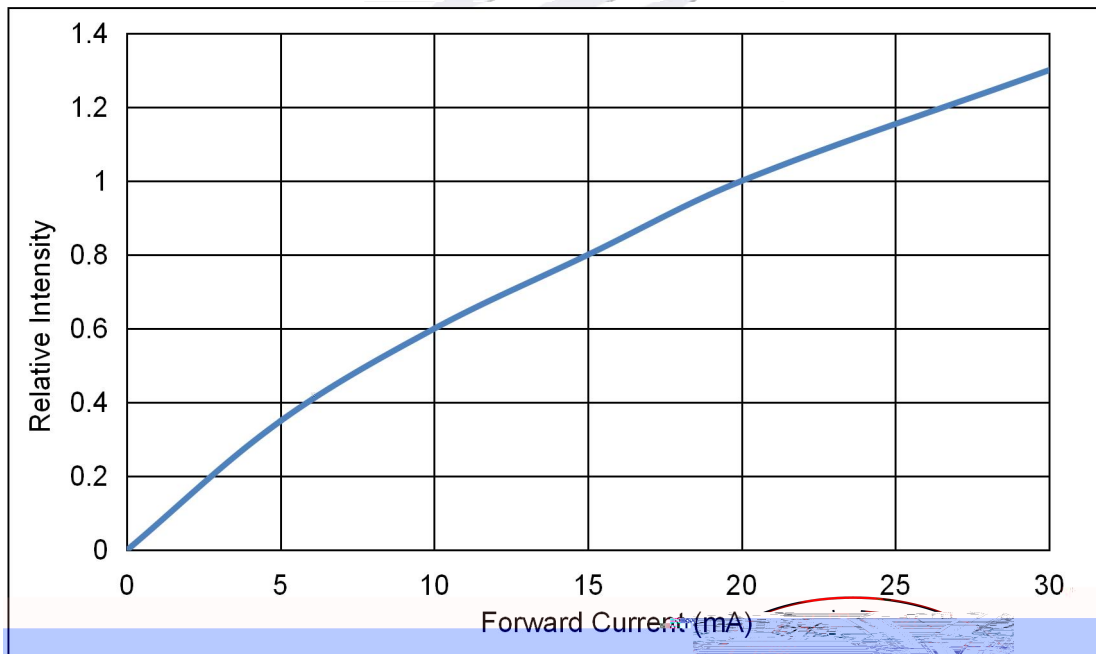
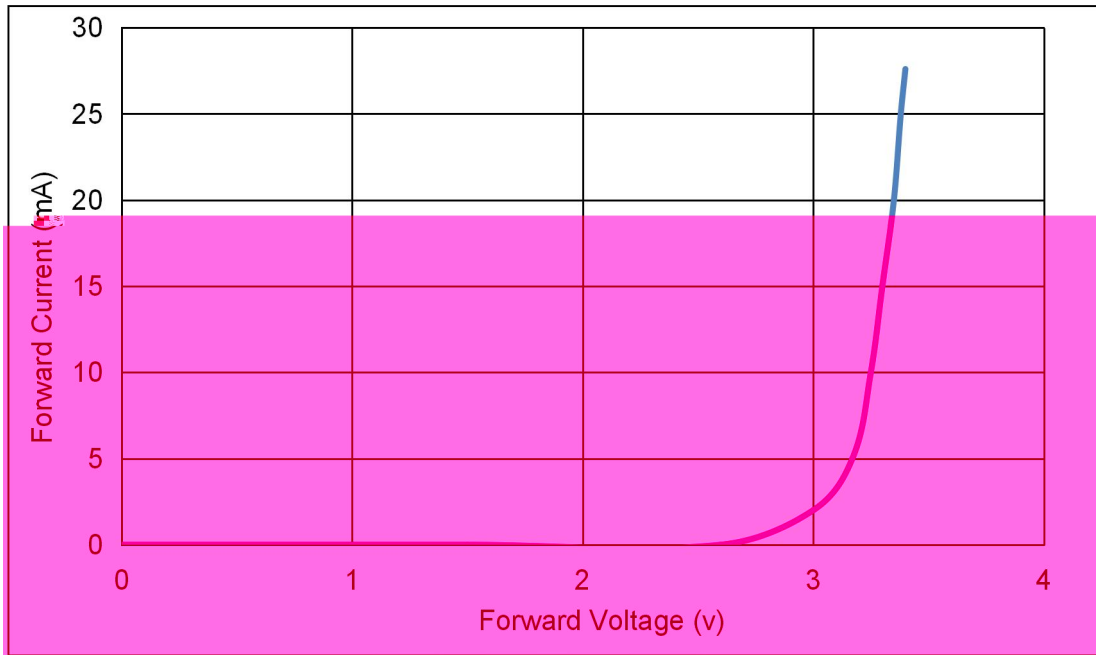

承认专用章



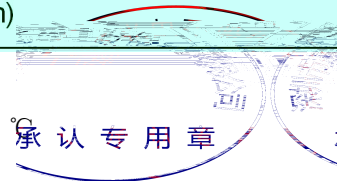
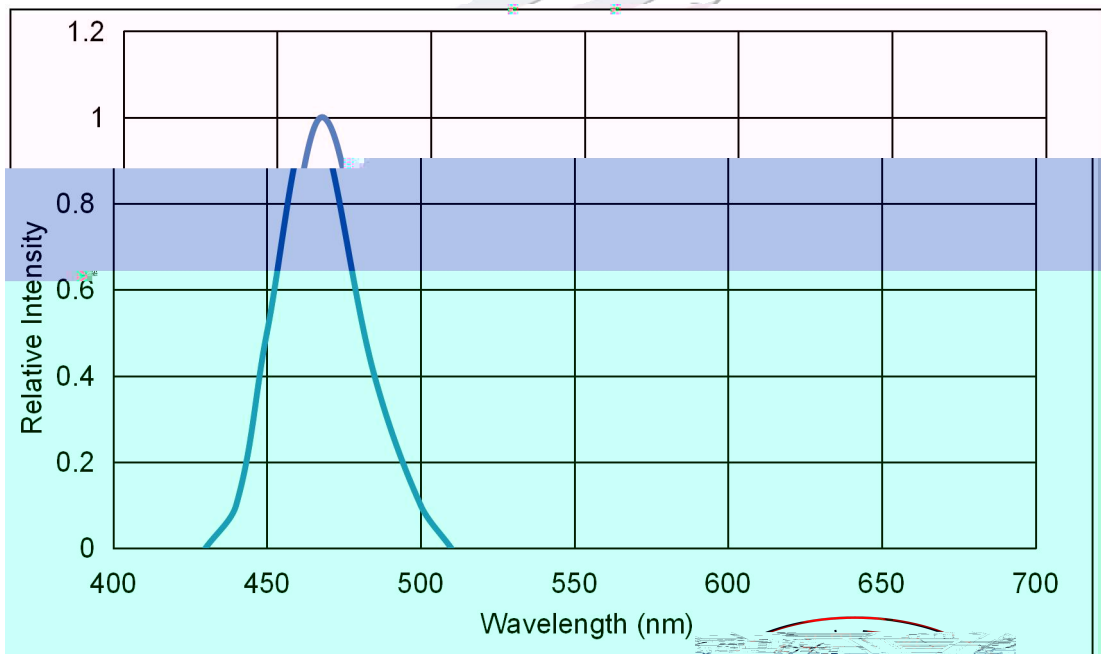
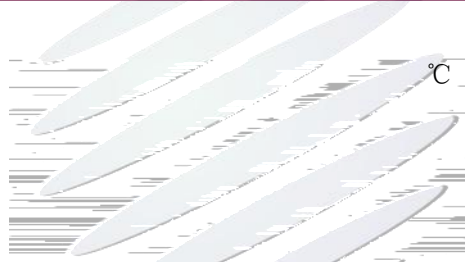
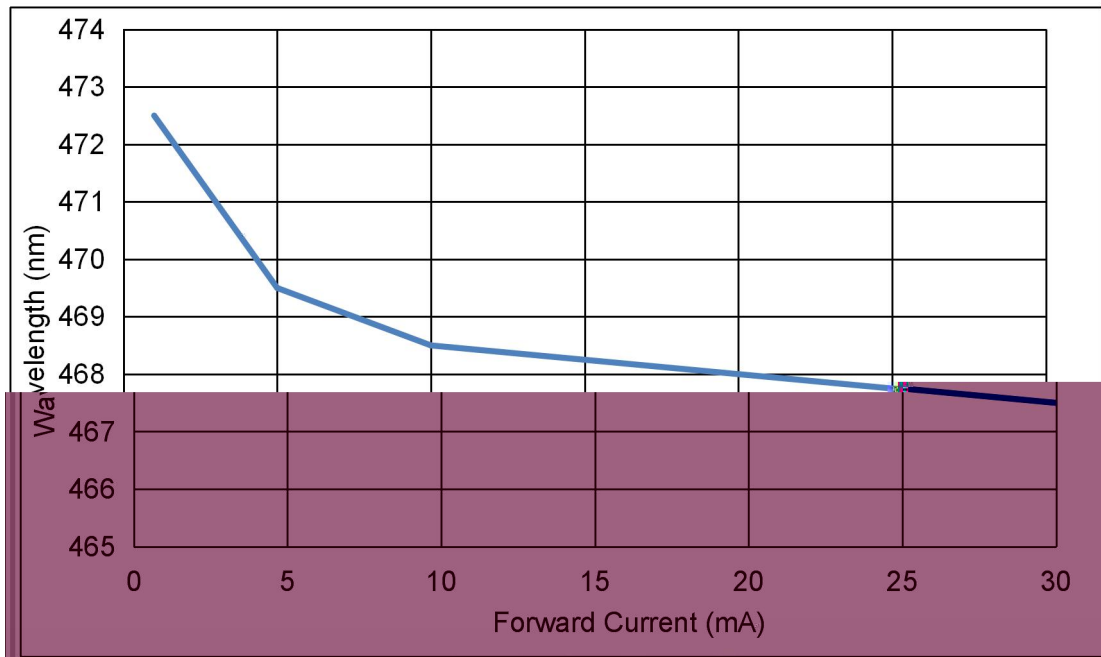

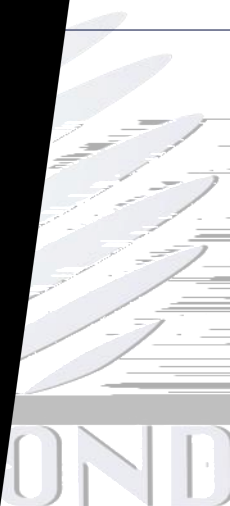
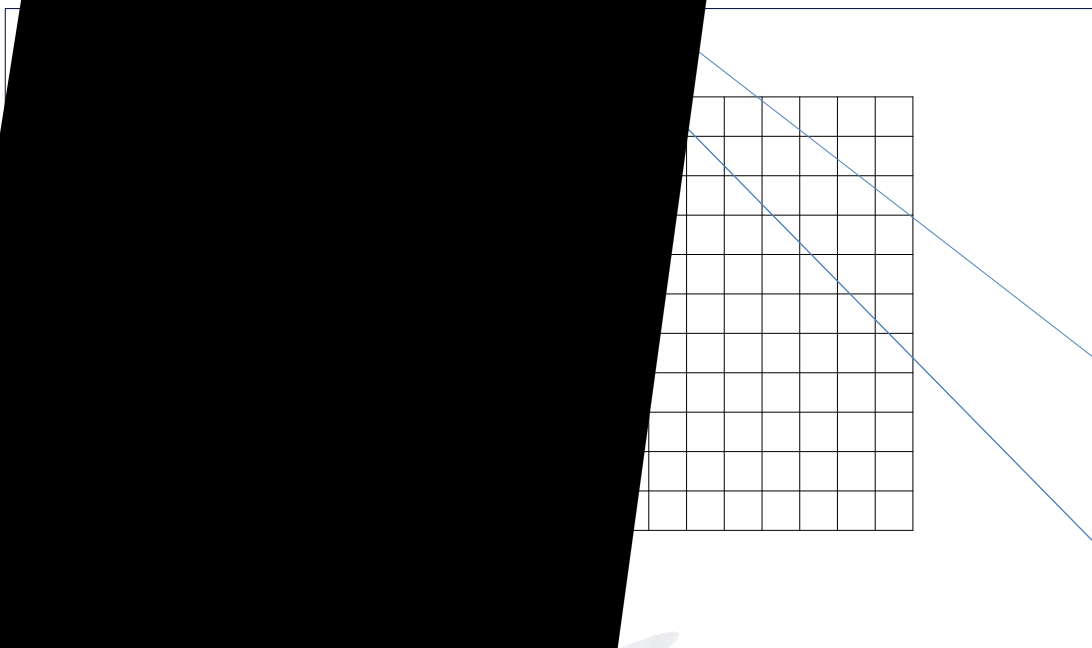

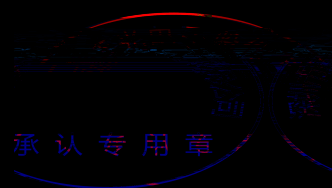

REFOND

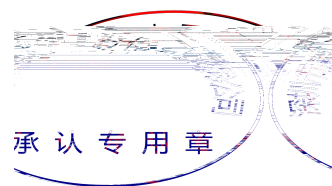
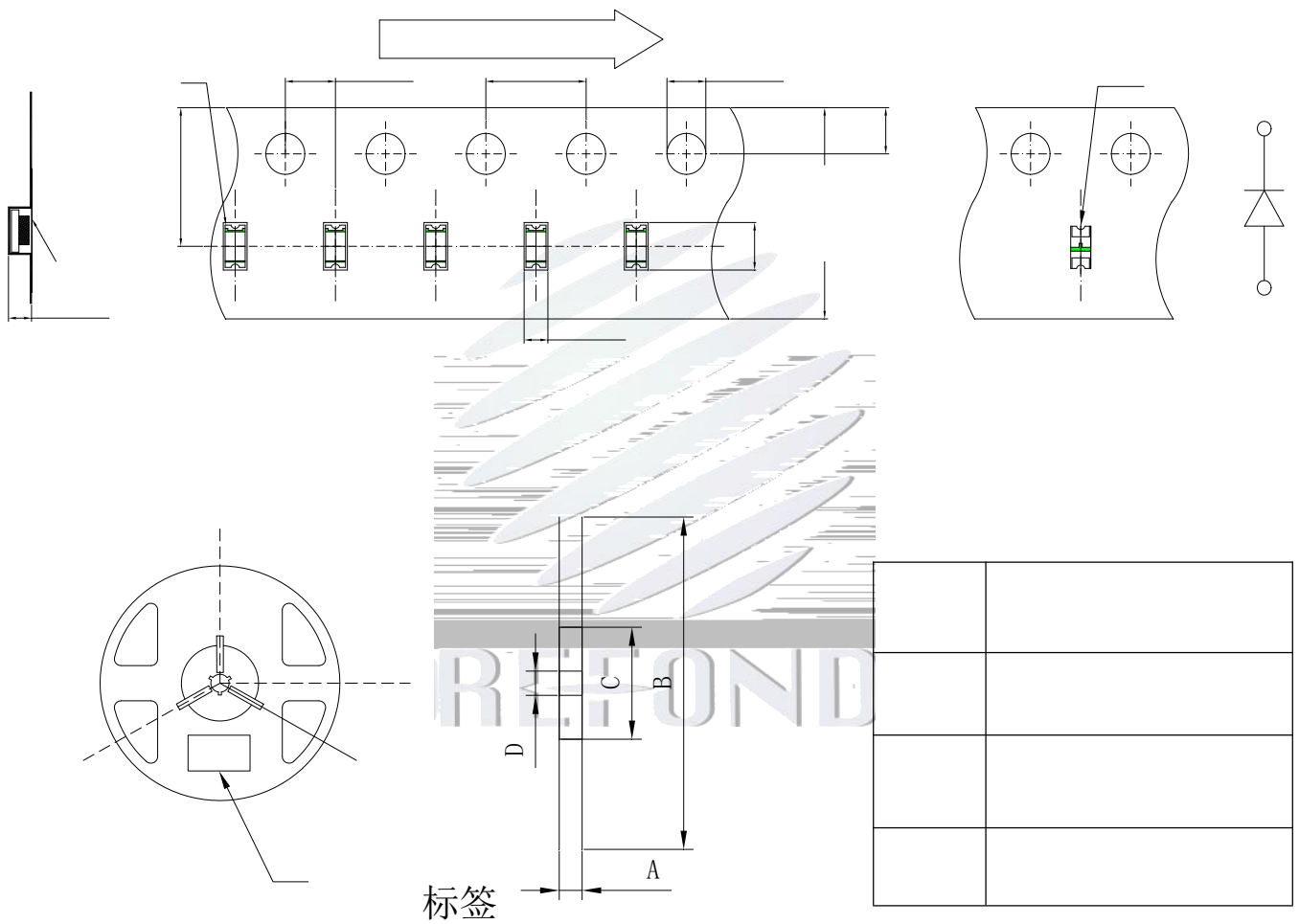



PART NO:		
SPEC NO:		
LOT NO		
BIN CODE:		
Φ:	XY:	
VF:	WLD:	
	QTY:	
	DATE:	

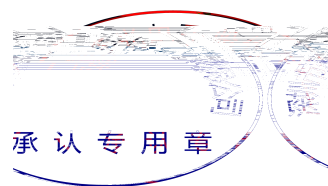
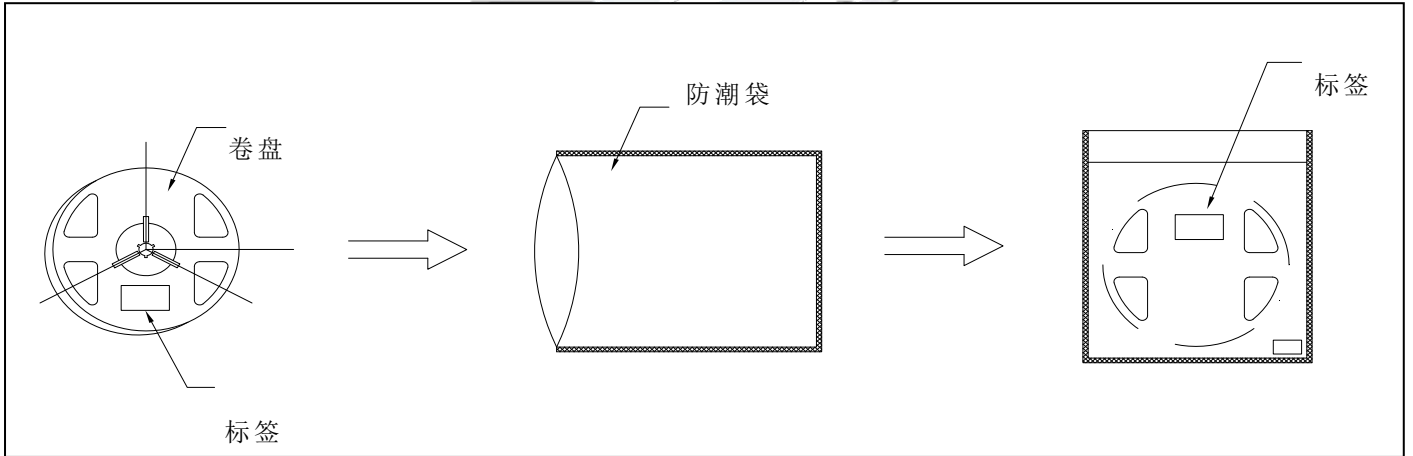

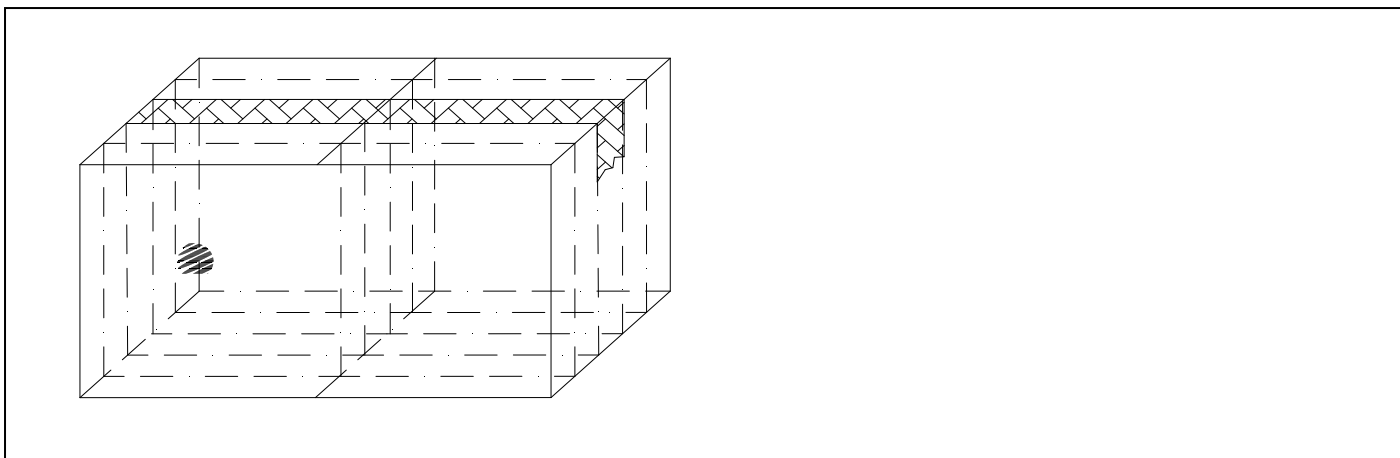

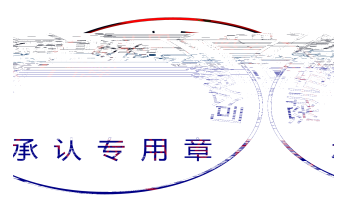

°C

