

# SPECIFICATION

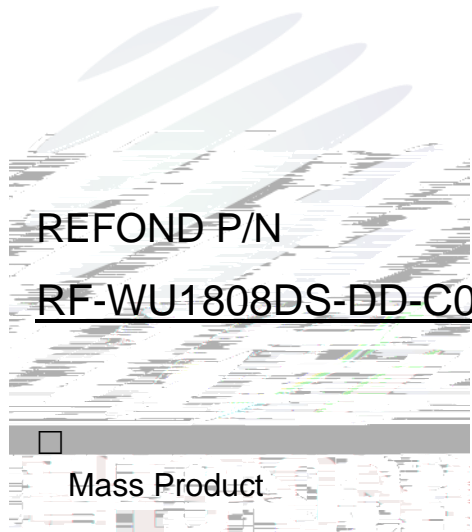

## Contents

1. Description

1.1 General Description

1.2 Features

1.3 Application

1.4 Package Dimension

1.5 Product Parameters

1.6 Bin Range Of Forward Voltage and Luminous Flux (IF=10mA)

BIN

(IF=10mA)

1.7 Typical Optical Characteristics Curves BT1 0 0.....7.CID 55>BDC BT/F8 12 Tf1 0 0 1 213.04 508

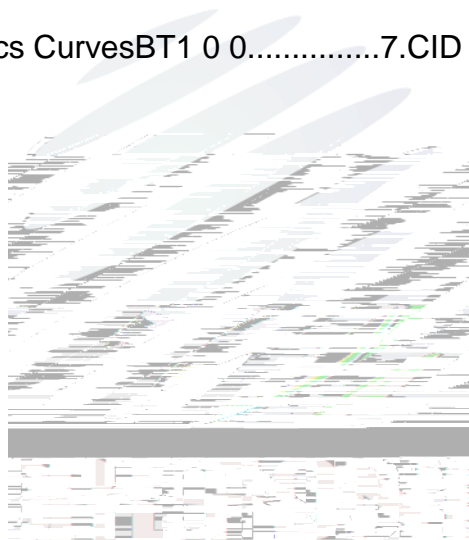

# 1. Description

## 1.1 General Description



The White LED, which was fabricated by using a blue chip and the phosphor.  
Product Package:1.8mmX0.8mmX0.5mm.

## 1.2 Features

Extremely wide viewing angle.

Suitable for all SMT assembly and solder process.

Moisture sensitivity level: Level 3. Level 3

RoHS compliant. RoHS

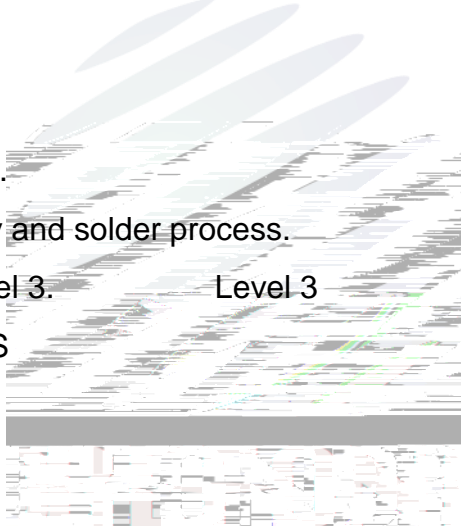

## 1.3 Application

Optical indicator.

Switch and Symbol, Display.

General use.



## 1.4 Package Dimension

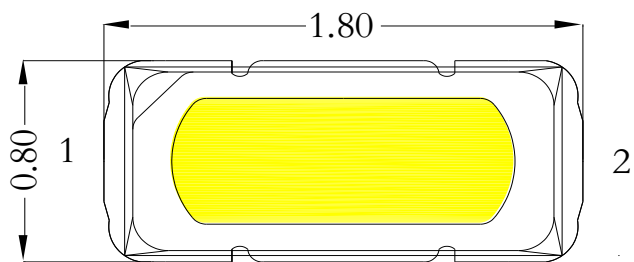

Fig.1-1 Top view

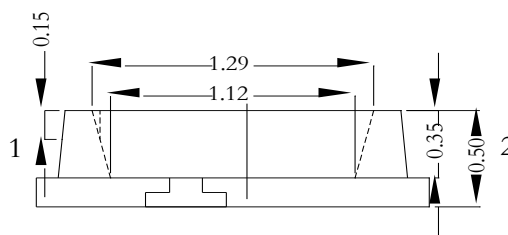

Fig.1-2 Side view

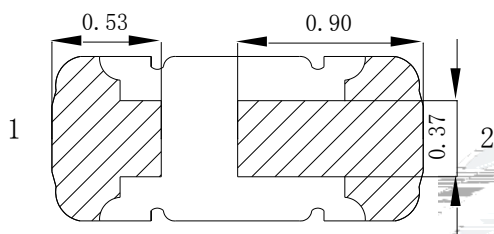

Fig.1-3 Bottom view

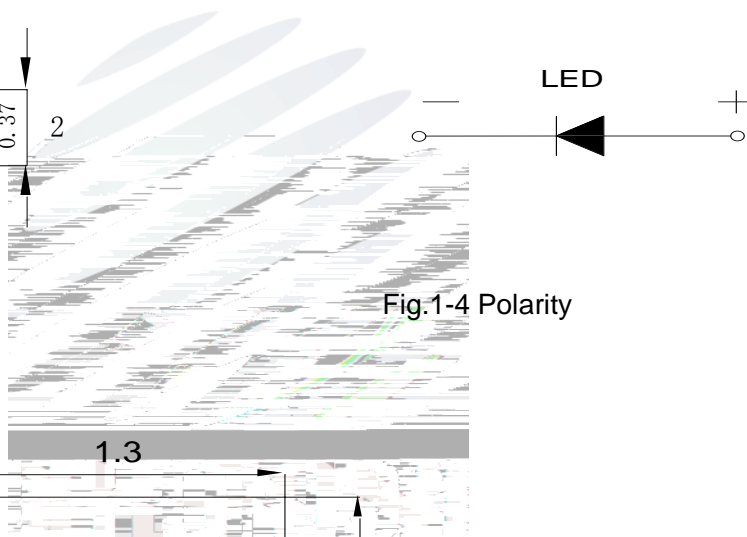

Fig.1-4 Polarity

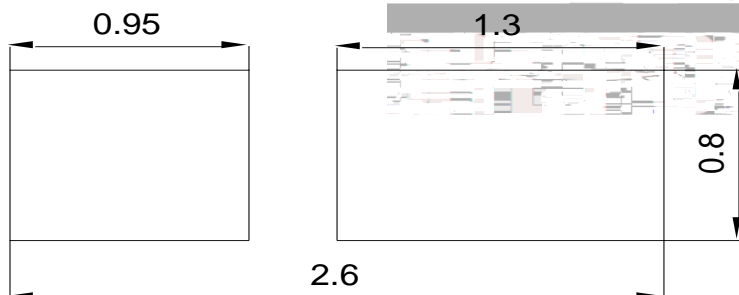

Fig.1-5 Soldering patterns

### Notes

All dimensions units are millimeters.

All dimensions tolerances are  $\pm 0.2\text{mm}$  unless otherwise noted.



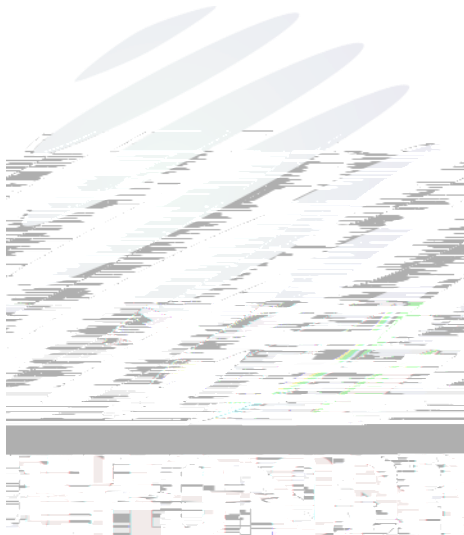

Table 1-2 Absolute Maximum Ratings at Ts=25°C

Parameter

Notes

1. 1/10 Duty cycle, 0.1ms pulse width.
2. The above forward voltage measurement allowance tolerance is  $\pm 0.1V$ .
3. The above color coordinates measurement allowance tolerance is  $\pm 0.005$ .
4. The above luminous intensity measurement allowance tolerance  $\pm 10\%$ .
5. Care is to be taken that power dissipation does not exceed the absolute maximum rating of the product.
6. All measurements were made under the standardized environment of Refond.
7. When the LEDs are in operation the maximum current should be decided after measuring the package temperature, junction temperature should not exceed the maximum rate

## 1.6 Bin Range Of Forward Voltage and Luminous Flux (IF=10mA)

BIN (IF=10mA)

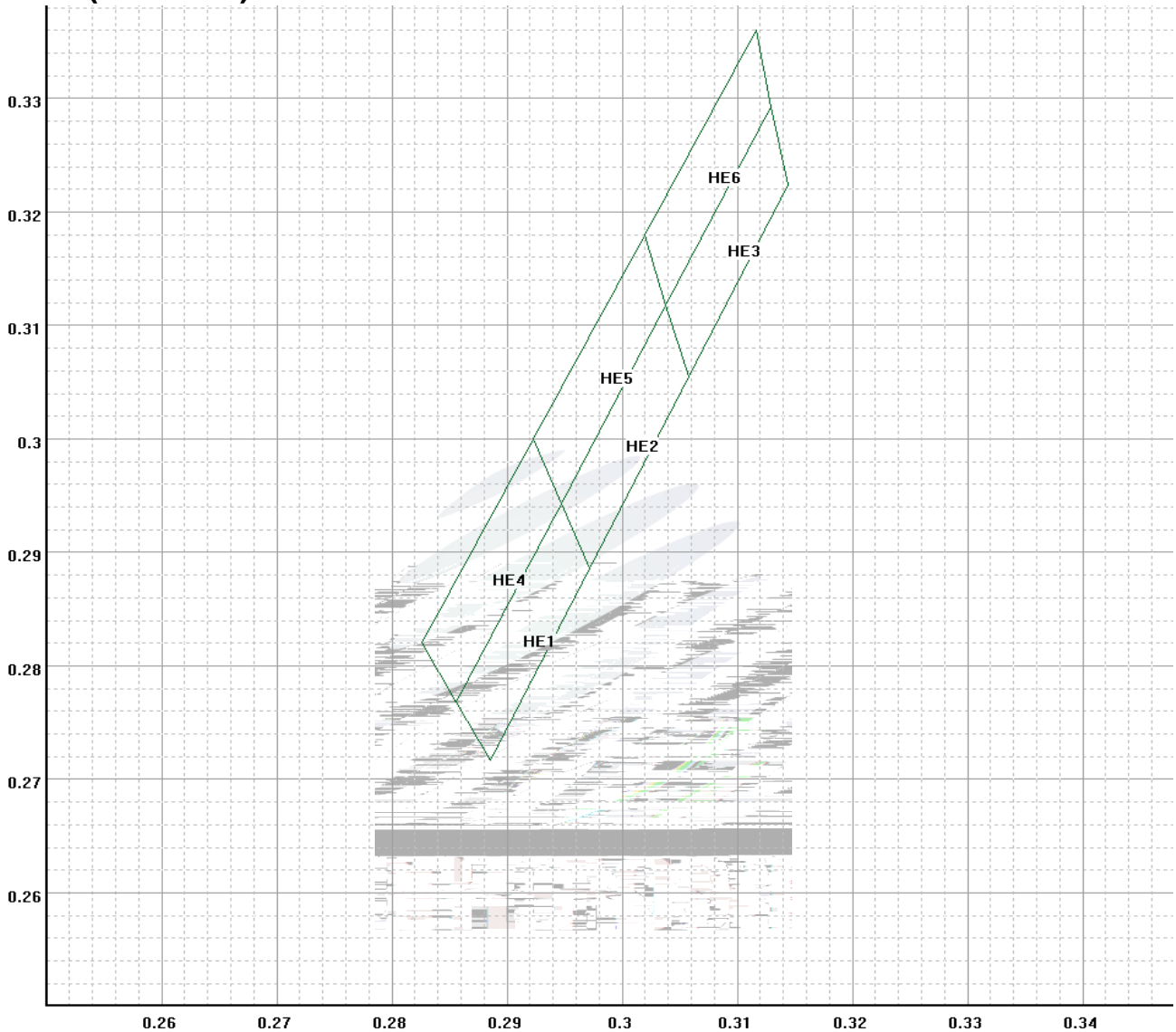

Fig. 1-6 The C.I.E Chromaticity Diagram CIE

Table 1-3 Bin Date Bin

BIN	X1	Y1	X2	Y2	X3	Y3	X4	Y4
HE1	0.2886	0.2716	0.2856	0.2767	0.2947	0.2942	0.2972	0.2885
HE2	0.2972	0.2885	0.2947	0.2942	0.3038	0.3117	0.3058	0.3054
HE3	0.3058	0.3054	0.3038	0.3117	0.3129	0.3292	0.3144	0.3223
HE4	0.2856	0.2767	0.2826	0.2819	0.2923	0.2999	0.2947	0.2942
HE5	0.2947	0.2942	0.2923	0.2999	0.302	0.3179	0.3038	0.3117
HE6	0.3038	0.3117	0.302	0.3179	0.3117	0.3359	0.3129	0.3292

## 1.7 Typical Optical Characteristics Curves

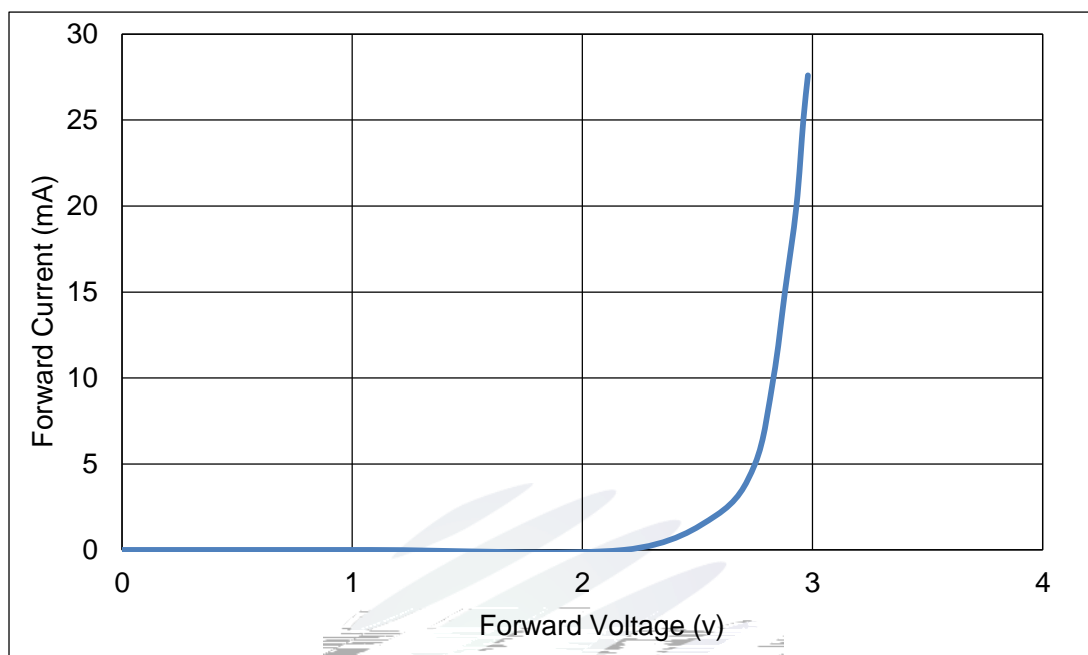

Fig. 1-7 Forward Voltage Vs Forward Current

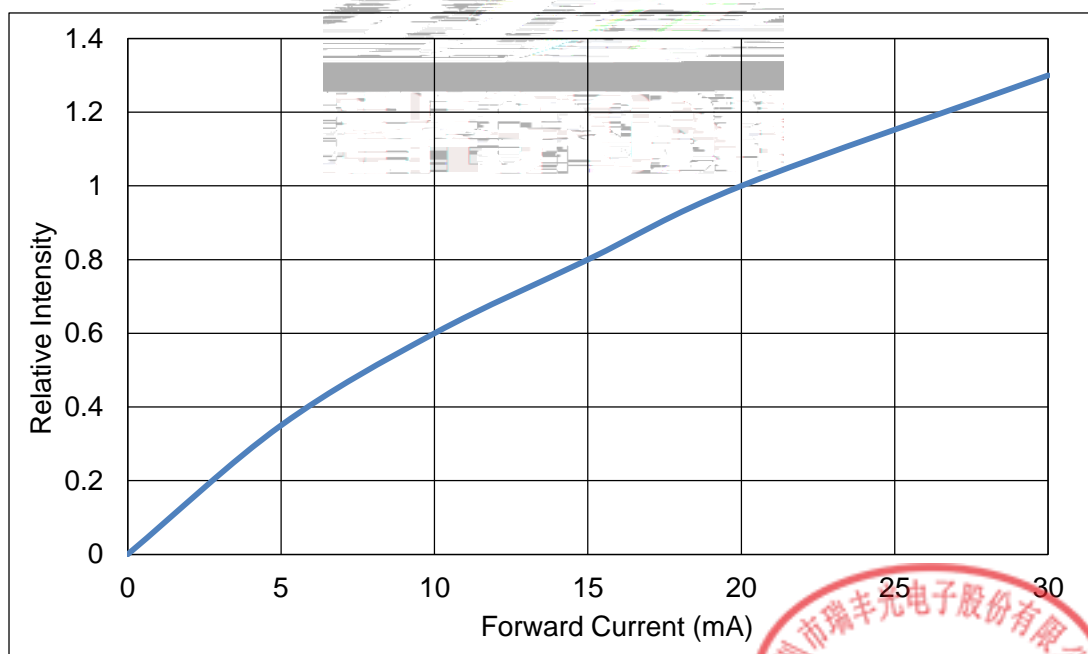
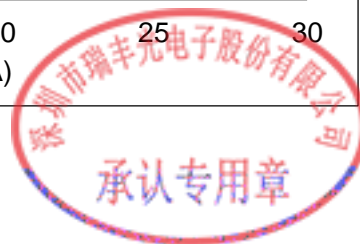

Fig. 1-8 Forward Current Vs Relative Intensity



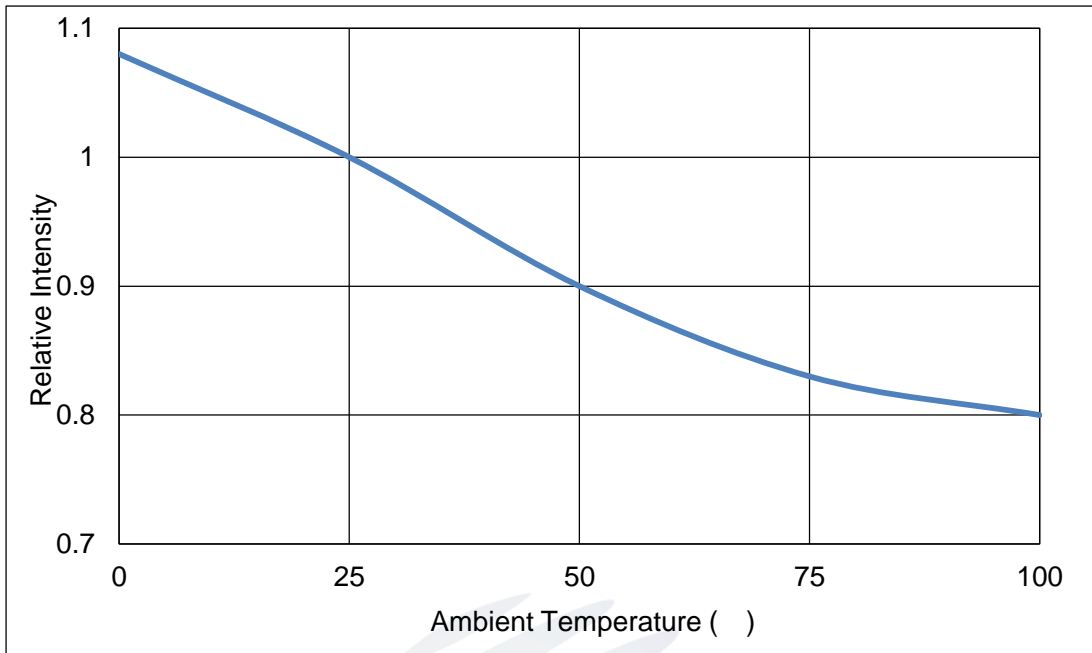

Fig. 1-9 Pin Temperature Vs Relative Intensity

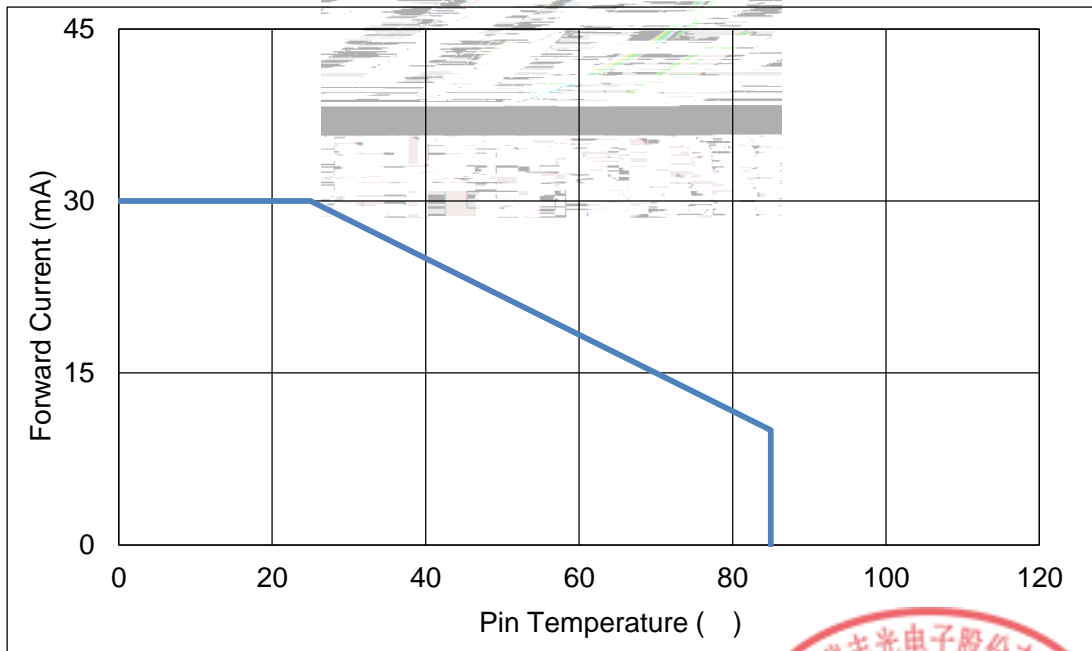

Fig. 1-10 Pin Temperature Vs Forward Current



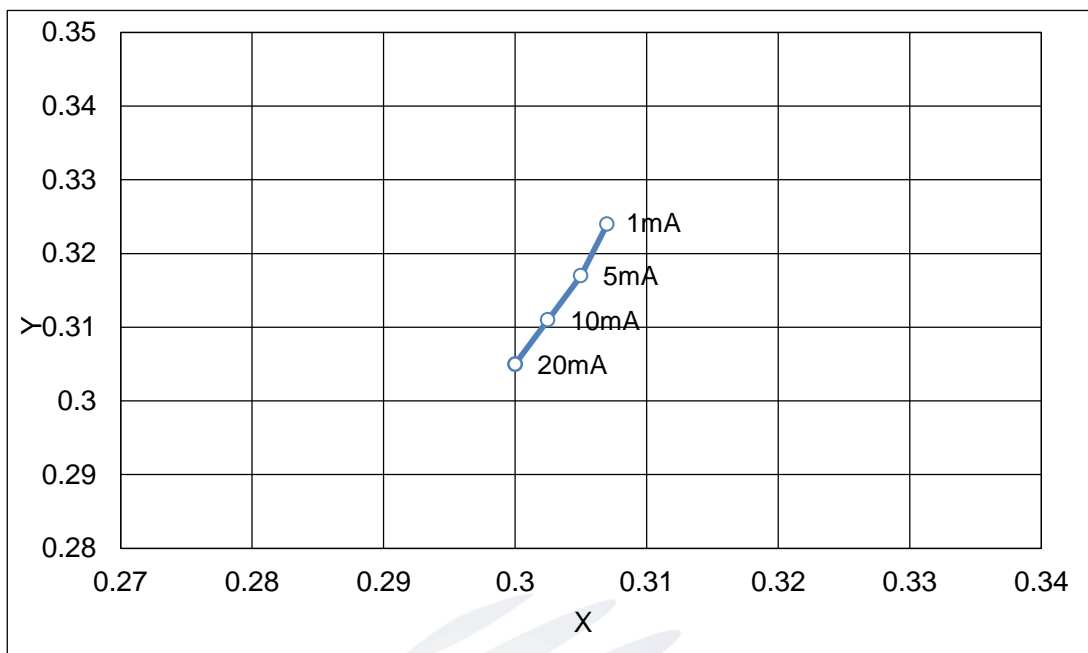

Fig. 1-11 Forward Current Vs Dominate Wavelength (Ta=25 )

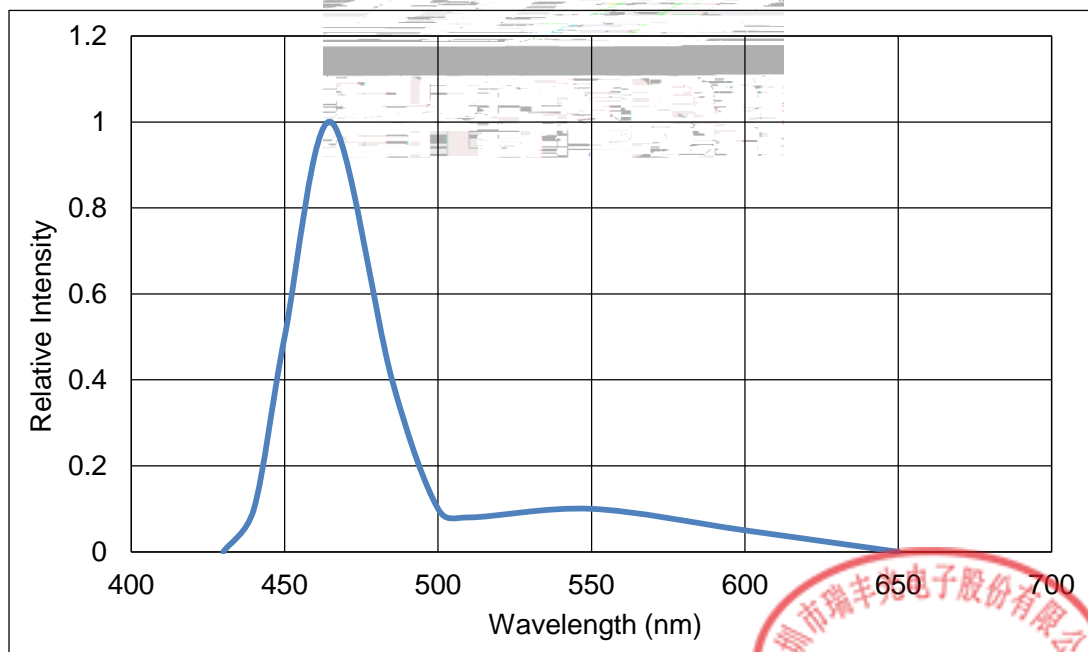

Fig. 1-12 Relative Intensity Vs Wavelength (Ta=25 )



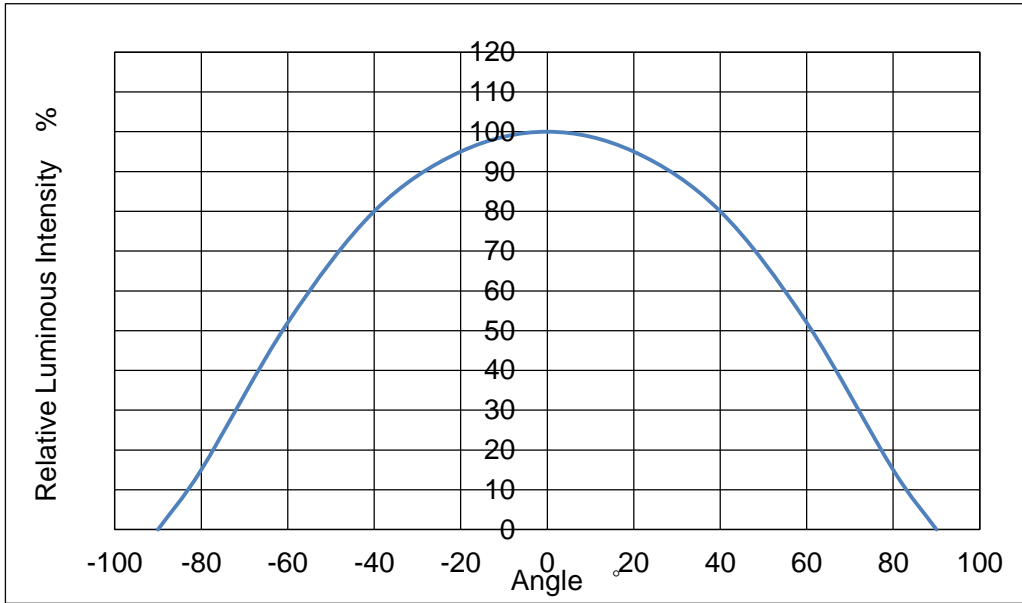
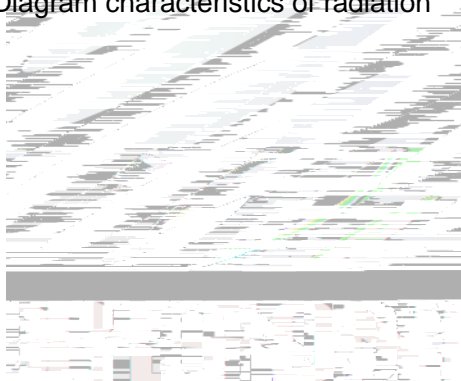

Fig. 1-13 Diagram characteristics of radiation



## 2. Packaging

### 2.1 Packaging Specification

Package: 4000pcs/reel.

4000pcs

#### 2.1.1 Carrier Tape Dimension

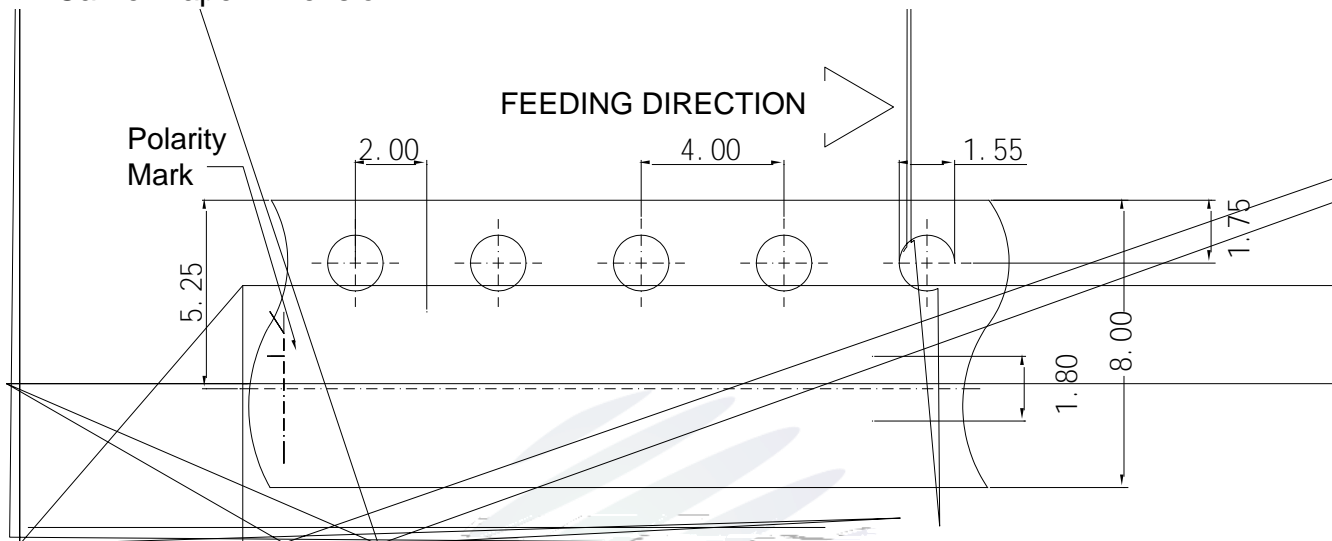

Fig.2-1 Carrier Tape Dimension

#### 2.1.2 Reel Dimension

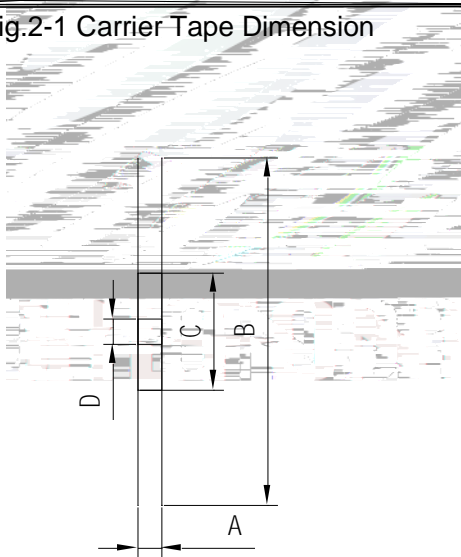
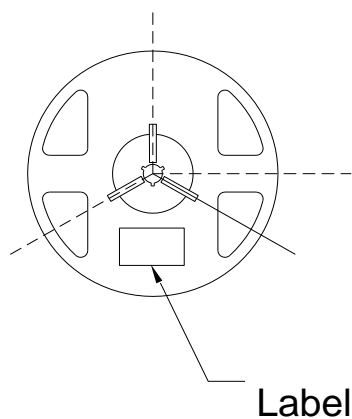

Table 2-1 Dimension

A	8.0 0.1mm
B	178 1mm
C	60 1mm
D	13.0 0.5mm

Fig.2-2 Reel Dimension

#### Notes

The tolerances unless mentioned  $\pm 0.1\text{mm}$ . Unit : mm



### 2.1.3 Label Form Specification

PART NO:		
SPEC NO:		
LOT NO		
BIN CODE:		
Φ:	XY:	
VF:	WLD:	
		
		
		QTY:
		DATE:

Table 2-2 Parameter

PART NO.	Part Number
SPEC NO.	Spec Number
LOT NO.	Lot Number
BIN CODE	Bin Code
	Luminous flux
XY	Chromaticity Bin
V <sub>F</sub>	Forward Voltage
WLD	Wavelength
QTY	Packing Quantity
DATE	Made Date

Fig. 2-3 Label Form Specification

### 2.2 Moisture Resistant Packing



Fig.2-4 Moisture Resistant Packing



## 2.3 Cardboard Box

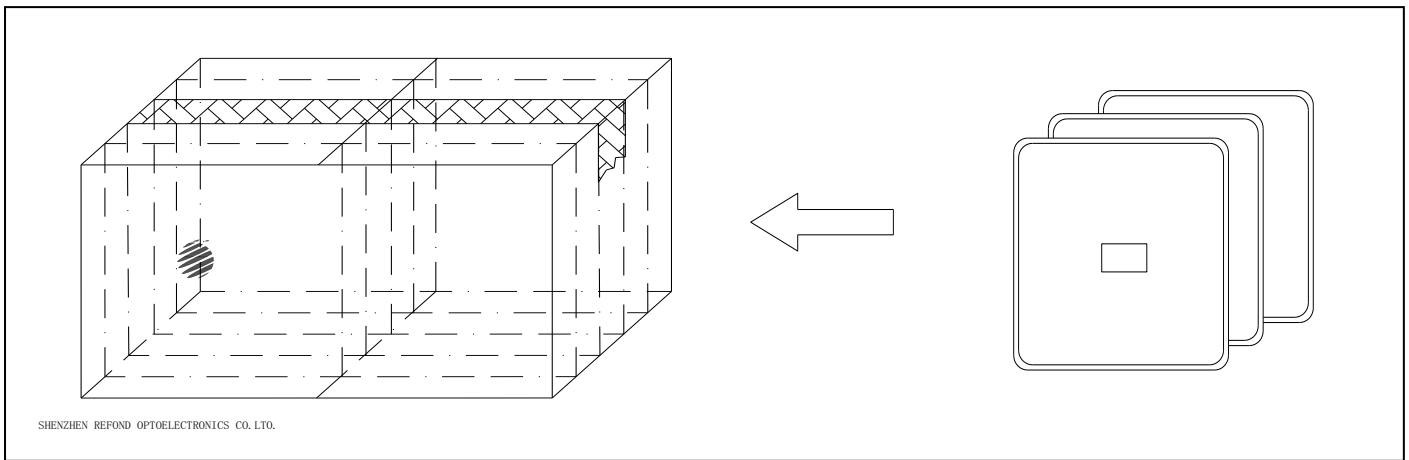

Fig.2-5 Cardboard Box

## 2.4 Reliability Test Items And Conditions

Table 2-3 Reliability Test Items And Conditions

Test Items	Ref.Standard	Test Condition	Time	Quantity	Ac/Re /
Reflow	JESD22-B106	Temp:260 max T=10 sec	2 times	22Pcs.	0/1
Temperature Cycle	JESD22-A104	100 30 min 5 min -40 30 min	100 cycles	22Pcs.	0/1
Thermal Shock	JESD22-A106	-40 15min 100 15min	300 cycles	22Pcs.	0/1
High Temperature Storage	JESD22-A103	Temp:100	1000 hrs.	22Pcs.	0/1
Low Temperature Storage	JESD22-A119	Temp:-40	1000 hrs.	22Pcs.	0/1
Life Test	JESD22-A108	T <sub>a</sub> =25 I <sub>F</sub> =10mA	1000 hrs.	22Pcs.	0/1



## 2.5 Criteria For Judging Damage

Table 2-4 Criteria For Judging Damage

Test Items	Symbol	Test Condition	Criteria For Judgement	
				Max.
Forward Voltage	$V_F$	$I_F=10\text{mA}$	-	$\text{U.S.L}^*)\times 1.1$
Reverse Current	$I_R$	$V_R=5\text{V}$	-	$\text{U.S.L}^*)\times 2.0$
Luminous Flux		$I_F=10\text{mA}$	$\text{L.S.L}^*)\times 0.7$	-

### Notes

1.U.S.L: Upper standard level

L.S.L: Lower standard level

2.The above reliability tests is based on the verification of a single/strip LED1 367.15 345.65 Tm[LET3 382)BTef\*463. 1

### 3. SMT Reflow Soldering Instructions SMT 回流焊说明

#### 3.1 SMT Reflow Soldering Instructions SMT

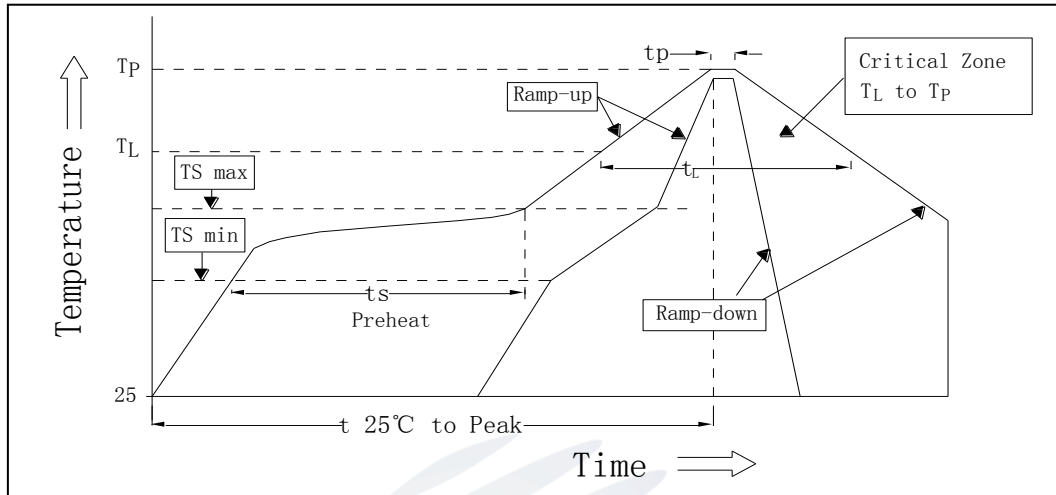
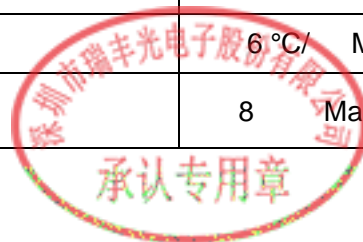

Fig.3-1 SMT Reflow Soldering Instructions SMT

Table 3-1 Parameter

Average temperature rise speed	Tsmax TP	3 °C/ Max 3 °C/ s
Preheating: minimum temperature	(Tsmín)	150 °C
Preheating: Max temperature	(Tsmáx)	200 °C
Preheating: Time	Tsmín Tsmax	60 - 120 60s-120s
Time limited to maintain high temperature: the temperature	(TL)	217 °C
Time limited to maintain high temperature: The Time	(tL)	60-150 60S-150S
Peak /Classification of temperature:	/ (TP)	260 °C
Time limit classification of peak temperature time	tp	10 Max 10s
Hold time within 5 °C with the actual peak temperature (TP)	(TP)	30 Max 30s
Cooling speed		6 °C/ Max 6 °C/ s
Needed time from 25 °C to TP	25 °C	8 Max 8 minutes



## Notes

(1)Reflow soldering should not be done more than twice. If more than 24 hours between the two solderings , LED will be damaged.

(2)Whensoldering , do not put stress on the LEDs during heating.

### 3.1.1 Soldering Iron

(1) When do soldering by hand, keep the temperature of iron below less 300°C less than 3 seconds.

(2) Soldering by hand should be done only one time.

### 3.1.2 Repairing

Repairing should not be done after the LEDs have been soldered. When repairing is unavoidable,a double-head soldering iron should be used (as below figure). It should be confirmed in advance whether the characteristics of LEDs will or not be damaged by repairing.

LED

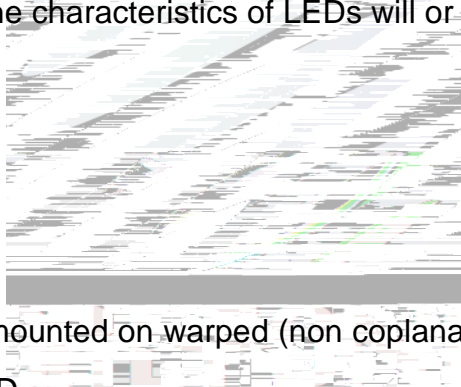

### 3.1.3 Cautions

(1) Components should not be mounted on warped (non coplanar) portion of PCB. After soldering, do not warp the circuit board.LED

(2) Do not apply mechanical force or excess vibration during the cooling process to normal temperature after soldering. Do not rapidly cool device after soldering.



## 4. Handling Precautions

### 4.1 Handling Precautions

(1) LED operating environment and sulfur element composition cannot be over 100PPM in the LED mating usage material. This is provided for informational purposes only and is not a warranty or endorsement. LED

(2) In order to prevent external material from getting into the inside of LED, which may cause the malfunction of LED, the single content of Bromine element is required to be less than 900PPM, the single content of Chlorine element is required to be less than 900PPM, the total content of Bromine element and Chlorine element in the external materials of the application products is required to be less than 1500PPM. This is provided for informational purposes only and is not a warranty or endorsement.

(3) VOCs (Volatile organic compounds) emitted from materials used in the construction of fixtures can penetrate silicone encapsulants of LEDs and discolor when exposed to heat and photonic energy. The result can be a significant loss of light output from the fixture. Knowledge of the properties of the materials selected to be used in the construction of fixtures can help prevent these issues. Refond advises against the use of any chemicals or materials that have been found or are suspected to have an adverse affect on device performance or reliability.

To verify compatibility, Refond recommends that all chemicals and materials be tested in the specific application and environment for which they are intended to be used. Attaching LEDs, do not use adhesives that outgas organic vapor.



(4) Handle the component along the side surface by using forceps or appropriate tools; Do not directly touch or Handle the silicone lens surface, it may damage the internal circuitry.

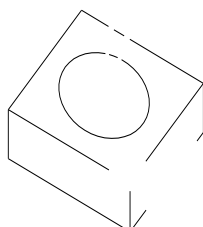
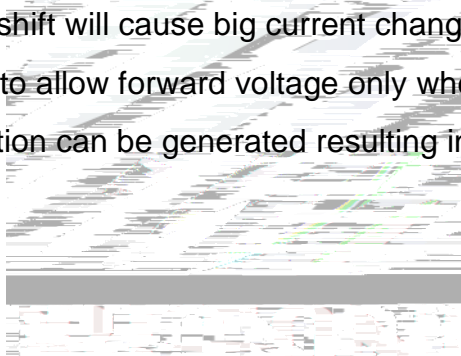

Fig 4-1

(5) In designing a circuit, the current through each LED can not exceed the absolute maximum rating specified for each LED. In the mean while, resistors for protection should be applied, otherwise slight voltage shift will cause big current change, burn out may happen. The driving circuit must be designed to allow forward voltage only when it is ON or OFF. If the reverse voltage is applied to LED, migration can be generated resulting in LED damage.



(6) Thermal Design is paramount importance because heat generation may result in the Characteristics decline, such as brightness decreased, Color change and so on. Please consider the heat generation of the LEDs when making the system design. LED

(7) Compared to standard encapsulants, silicone is generally softer, and the surface is more likely to attract dust, requiring special care during processing. In cases where a minimal level of dirt and dust particles cannot be guaranteed, a suitable cleaning solution must be applied to the surface after the soldering of components. Refond suggests using isopropyl alcohol for cleaning. In case other solvents are used, it must be assured that these solvents do not dissolve the package or resin. Ultrasonic cleaning is not recommended. Ultrasonic cleaning may cause damage to the

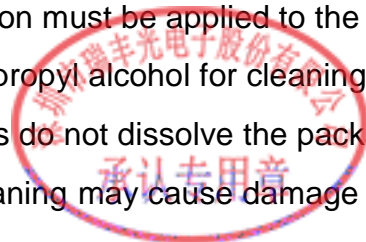

LED.

Table 4-1 Storage

Conditions	Temperature	Humidity	Time
Before Opening Aluminum Bag	30	75%	Within 1 Year From Date
Storage			
After Opening Aluminum Bag	30	60%	168hours
			168
Baking	60 5	-	24hours
			24

(8) If the moisture absorbent material (silica gel) has faded away or the LEDs have exceeded the storage time, baking treatment should be performed after unpacking and based on the following condition (60±5) °C for above 24 hours.

If the package is flatulence or damaged, please notify the sales staff to assist.

(9) Similar to most Solid state devices; LEDs are sensitive to Electro-Static Discharge (ESD) and Electrical Over Stress (EOS).

(10) Other points for attention, please refer to our relevant information.





