

ECIFICA I N





..... 13
..... 13
..... 14

1. D

1.1 General Description

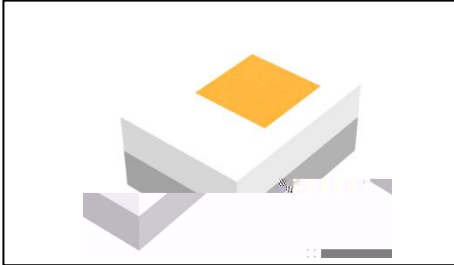

1.2 F



1.3 A







1.6 B F L F (IF=350 A)
 BIN (IF=350 A)

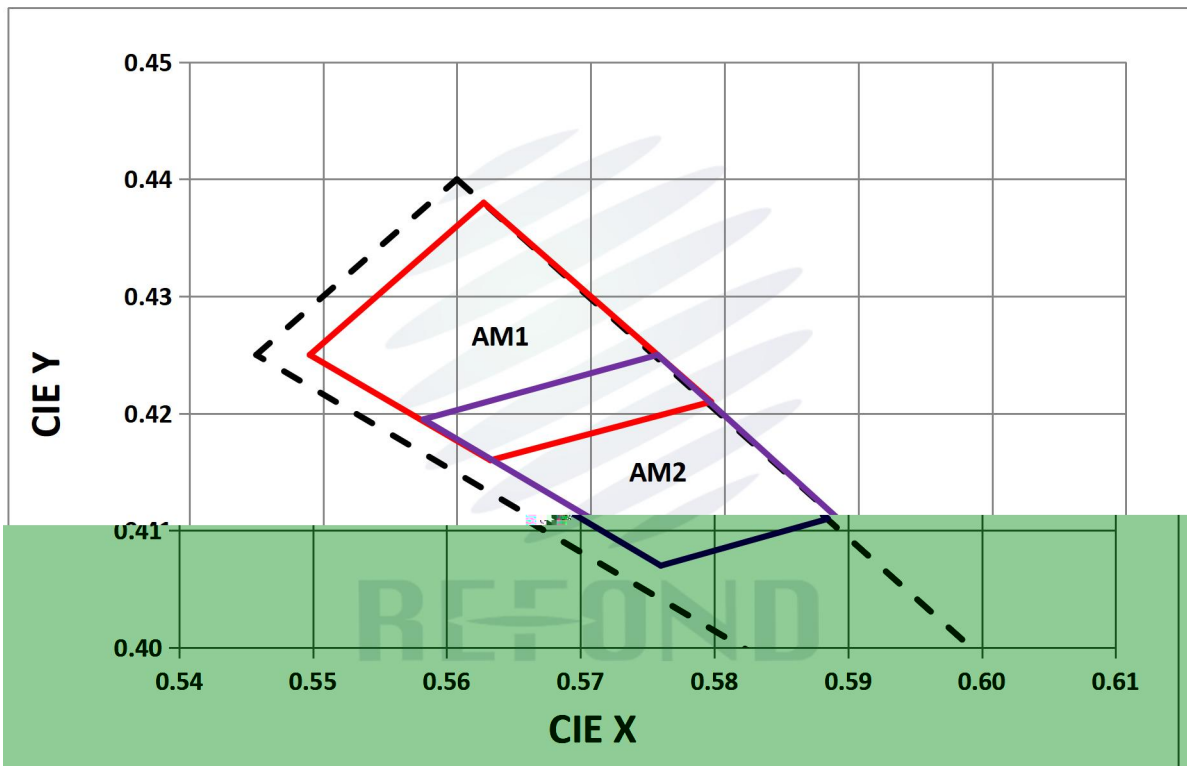

1.7

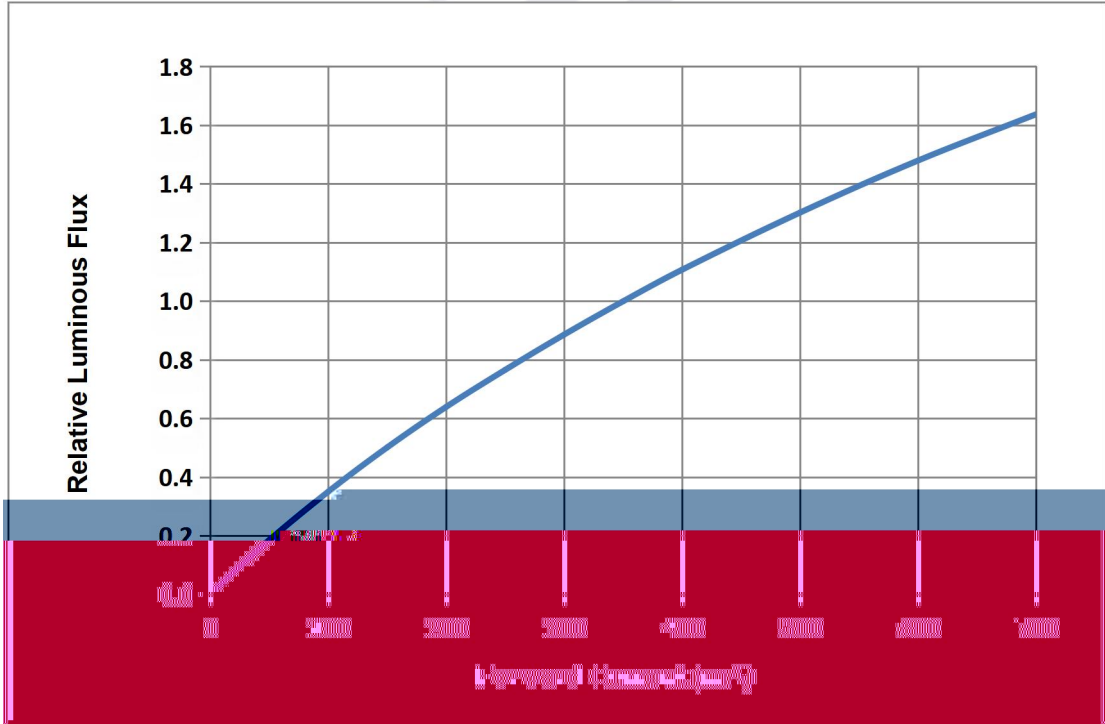
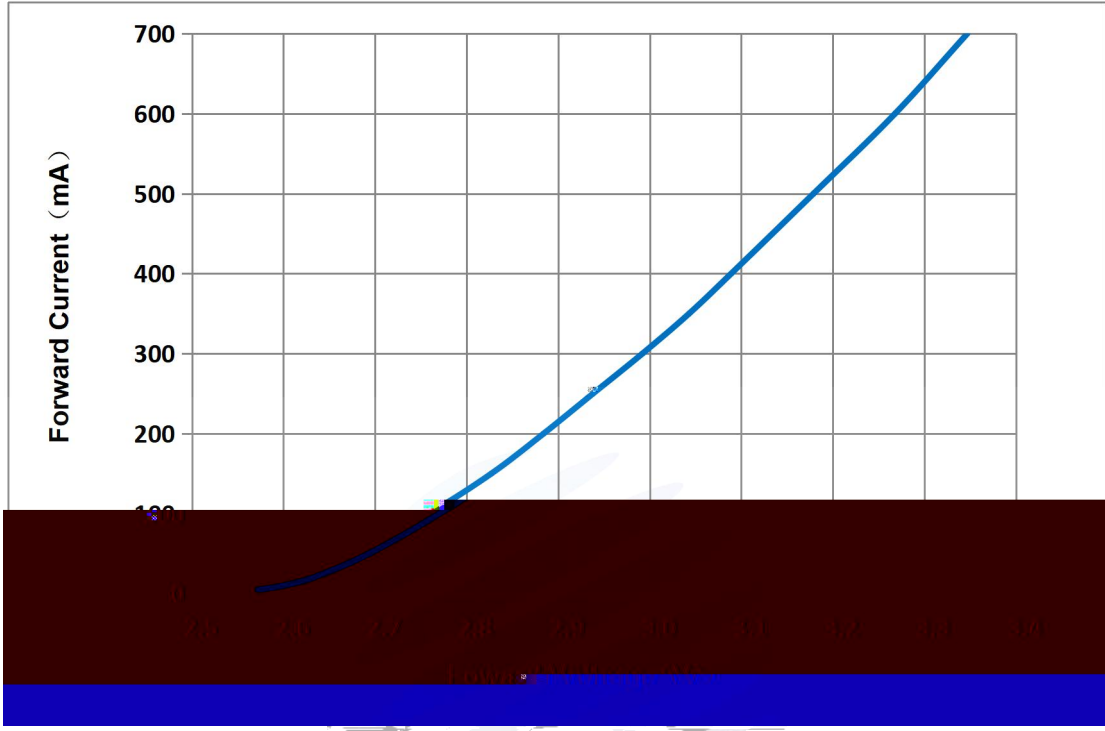

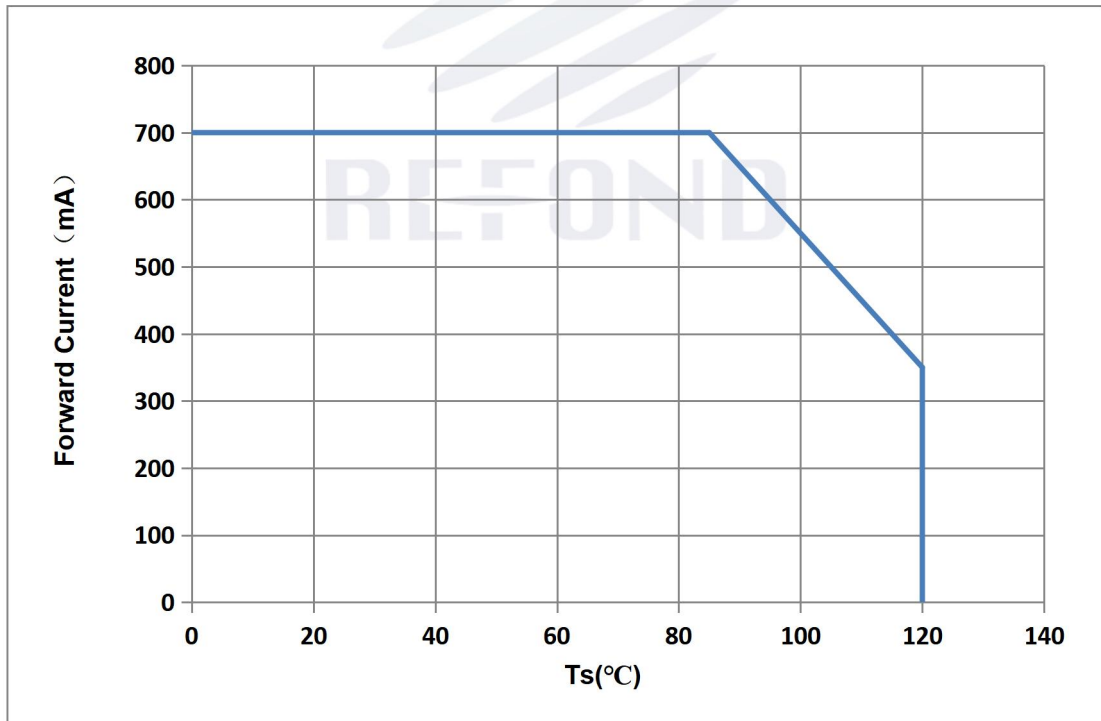
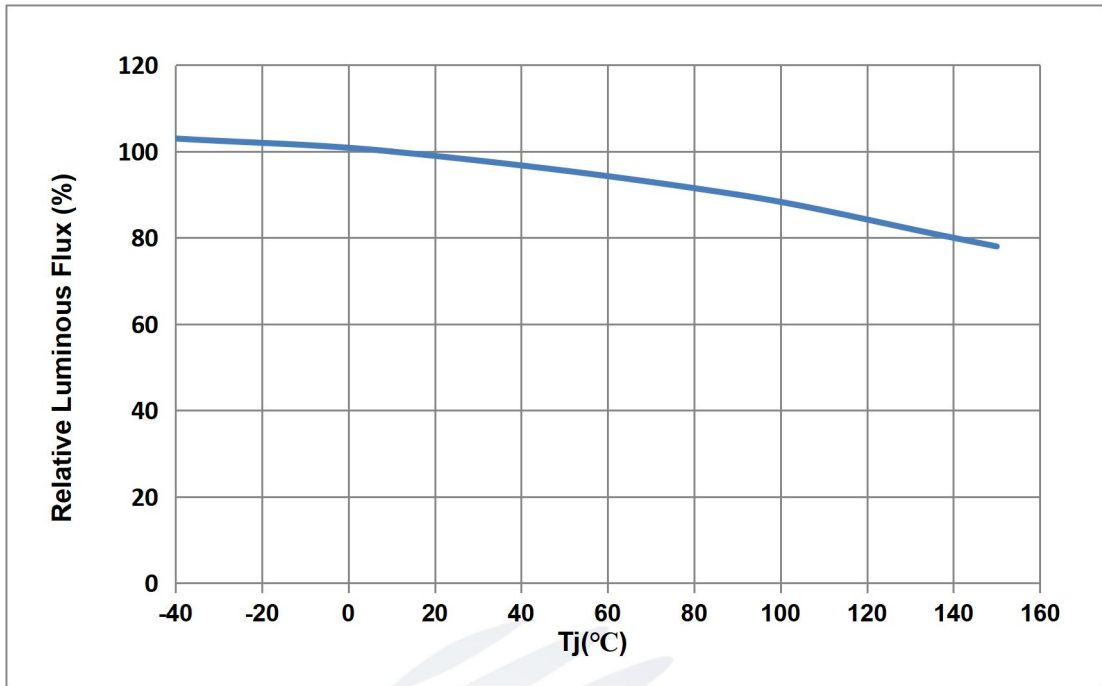

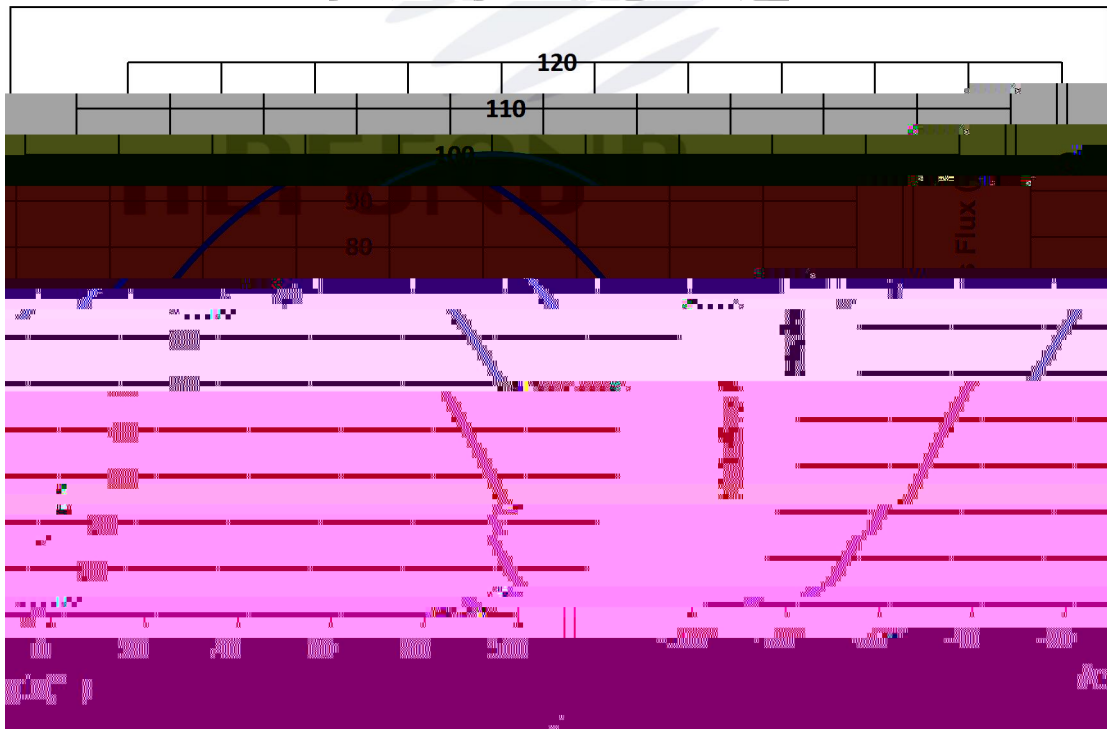
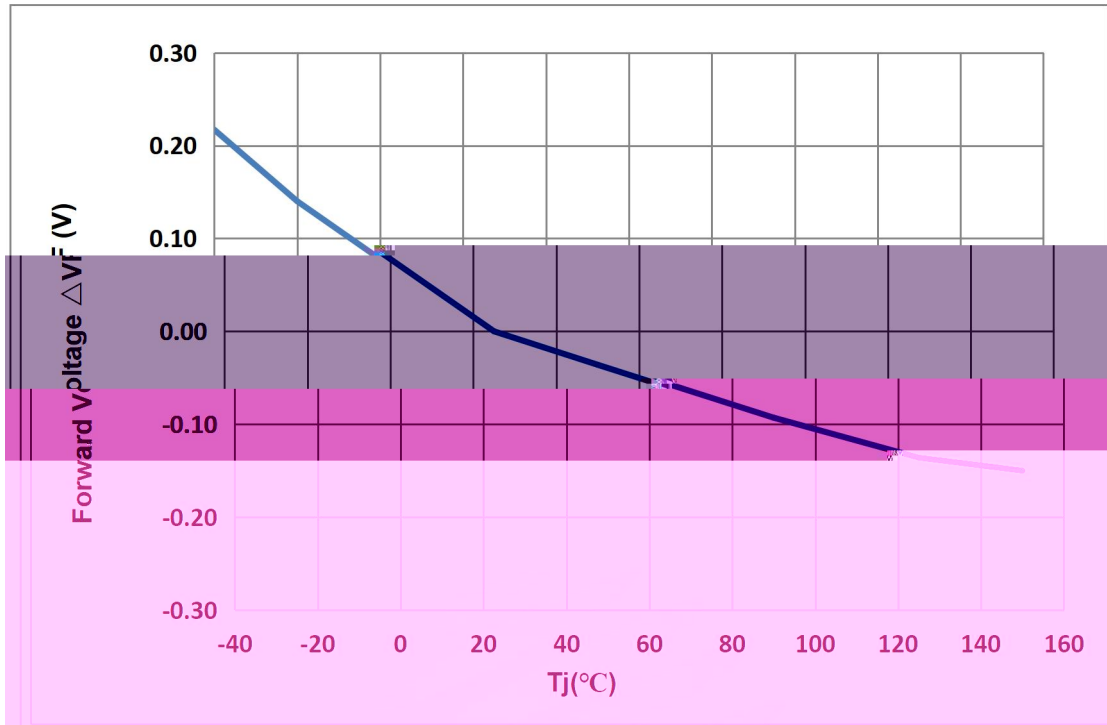

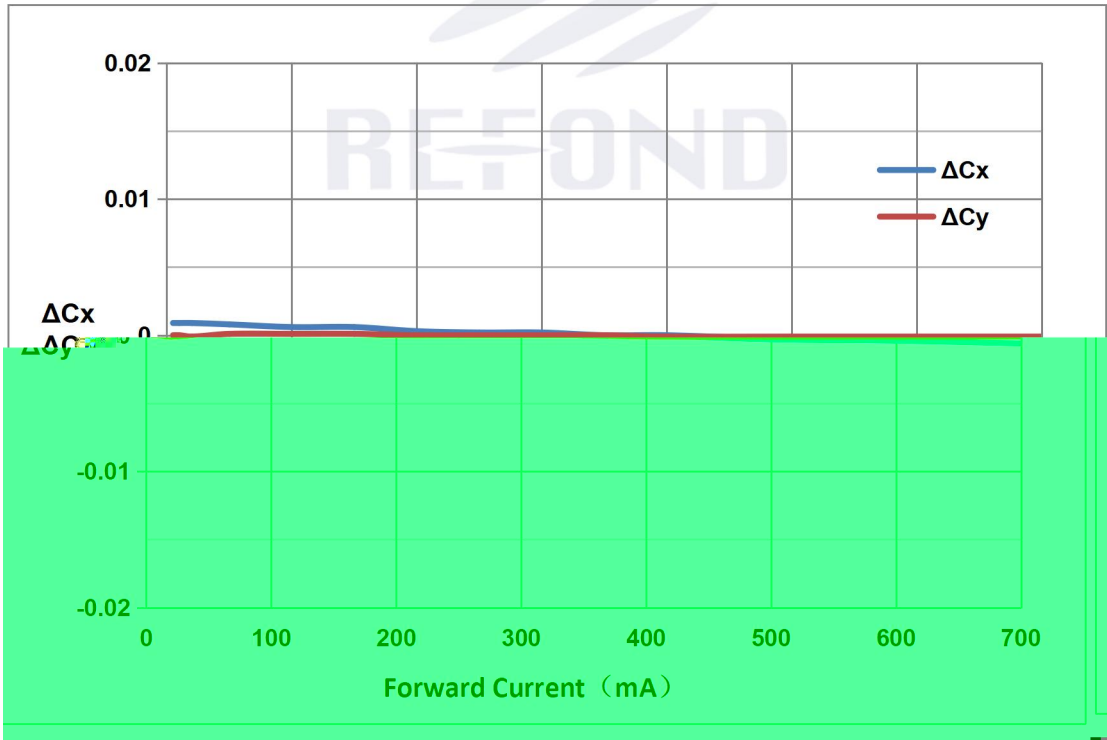
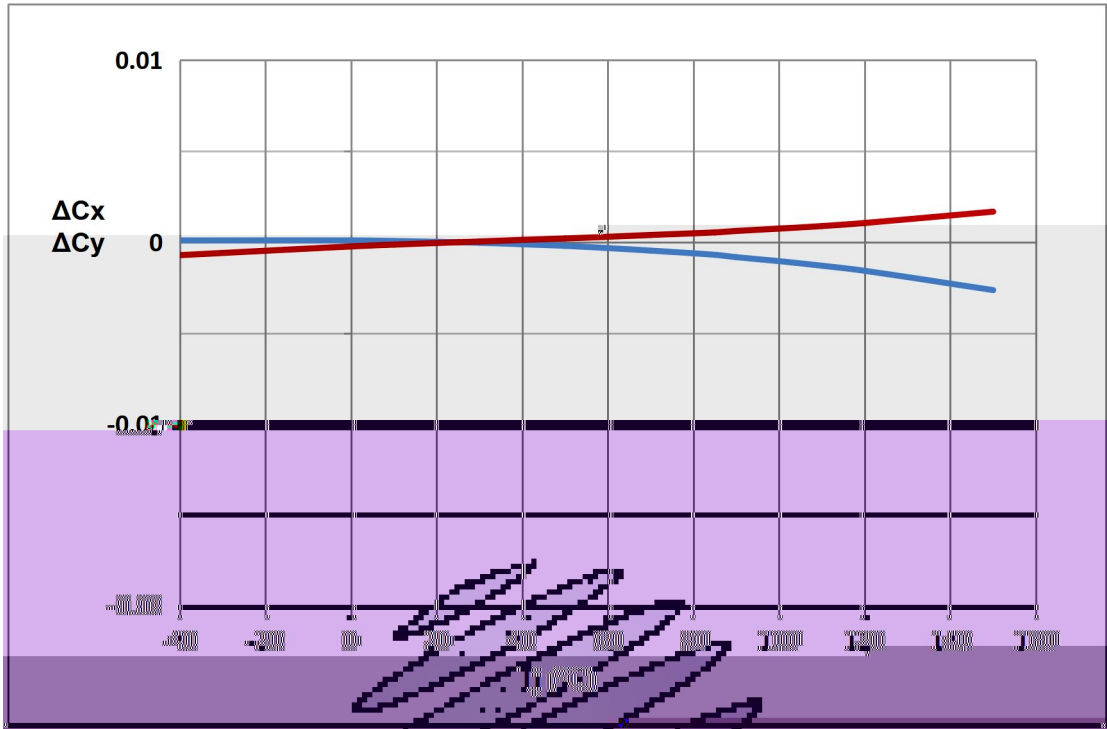

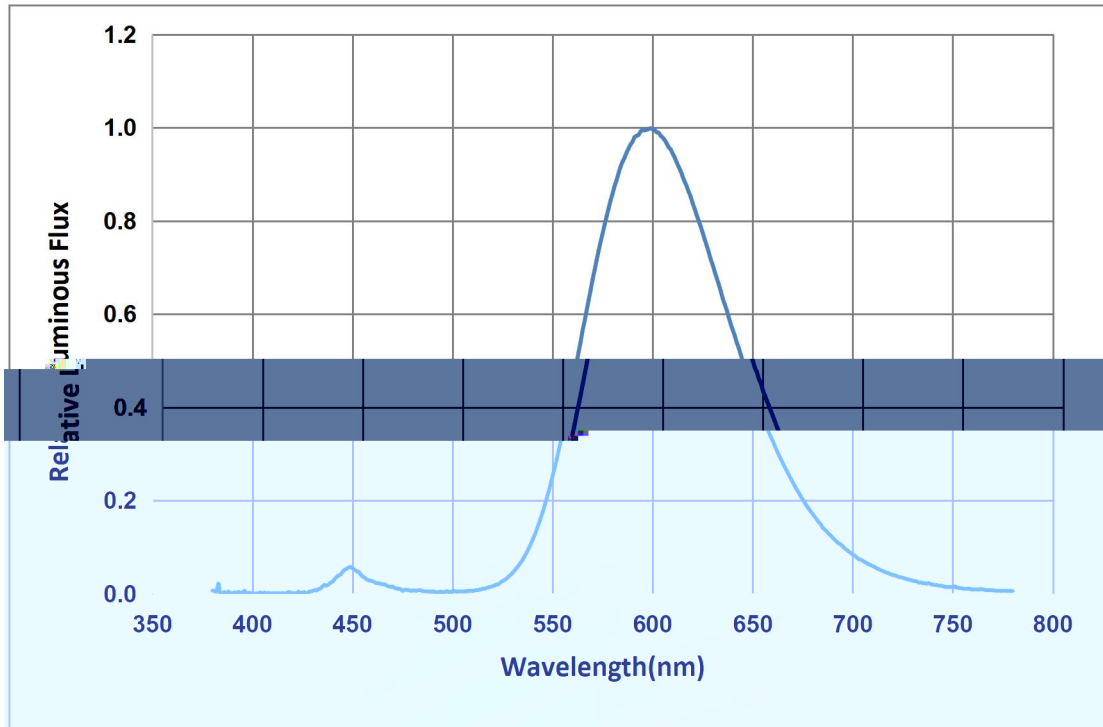

2.

2.1

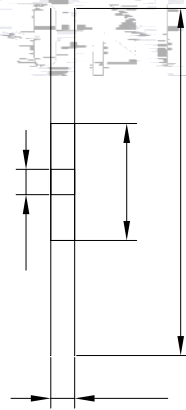
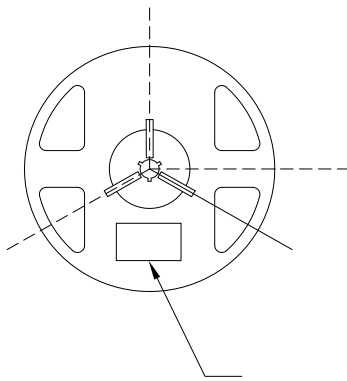
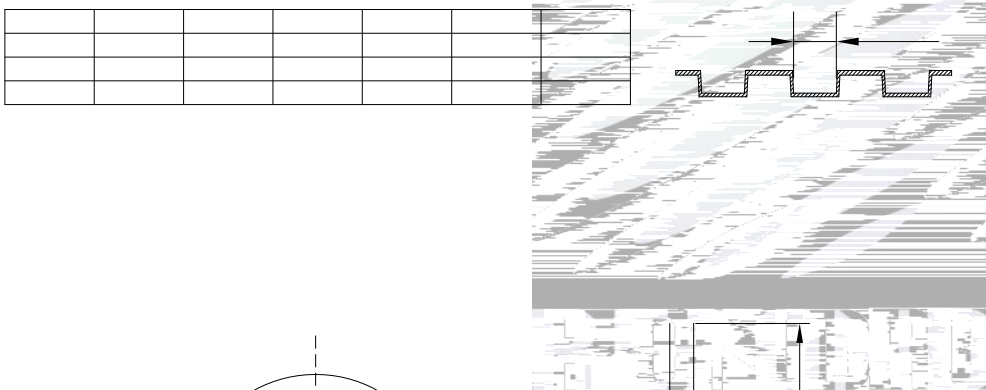
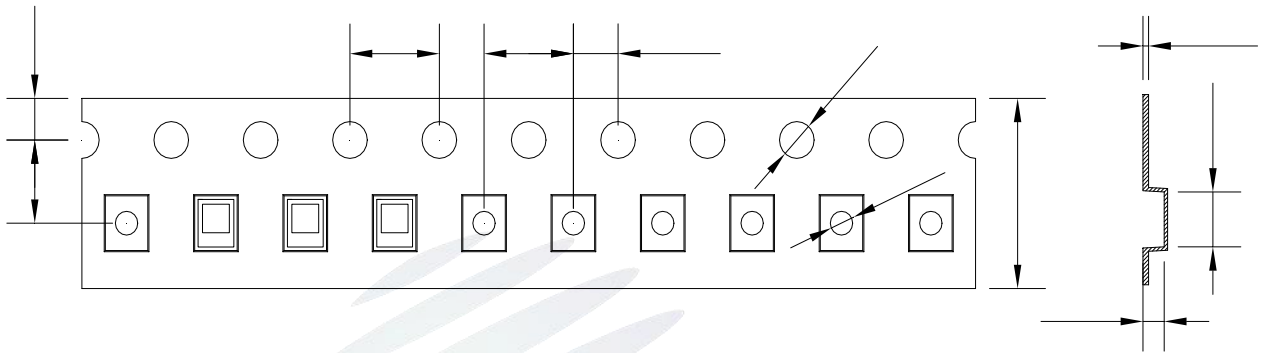

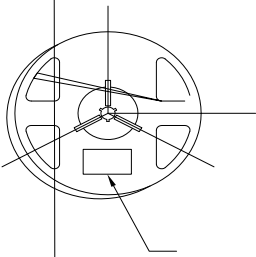

2.4 I A C

2.5 C F J D



3. M I M





4. H

4.1 H



